

Flamenco^{IP+}

Data Sheet Catalogue

From human to human.
The digital nurse call for hospitals.



Our policy of continual development means that product specification and appearance may change without notice. Tunstall does not accept responsibility for any errors and omissions within this document.

© 2021 Tunstall GmbH

Product overview

Loudspeaker with announcement interface	
Order no. 05 0024 02.	14
Loudspeaker set with anncmnt interface	
Order no. 05 0024 03.	15
Loudspeaker set	
Order no. 05 0024 04.	16
Pull cord call switch insert	
Order no. 29 0707 20F.	17
PrimusGlobal module Building Services	
Order no. 45 1400 00.	19
Call recording Flamenco, complete set	
Order no. 50 1027 10.	20
Universal sensor	
Order no. 61005/30.	21
Connection socket with call switch, bedhead unit	
Order no. 70 0171 50.	24
Connection socket with call switch	
Order no. 70 0171 60.	25
Connection socket combi	
Order no. 70 0425 00.	26
Connection socket combi, bedhead unit	
Order no. 70 0435 00.	27
Pear push switch	
Order no. 70 071x 0x.	28
Pear push switch	
Order no. 70 0712 00.	29
Sound detector	
Order no. 70 0790 01.	30
Connector interface module	
Order no. 70 0834 00.	31
Corridor display^{IP} Alpha 16	
Order no. 76 0150 00.	32
Corridor display^{IP} Alpha 16, double-sided	
Order no. 76 0160 00.	33
ComTerminal^{IP}, PoE	
Order no. 76 0510 00.	35
ComTerminal^{IP}, 24V	
Order no. 76 0510 10.	37
ComStation^{IP}	
Order no. 76 0605 50.	39
System module HEALTH	
Order no. 76 0730 00.	40
System module CARE	
Order no. 76 0735 00.	41

Function module UM/A	
Order no. 76 0740 00.....	42
Function module UMS/A	
Order no. 76 0740 01.....	43
Function module UMS/T	
Order no. 76 0740 10.....	44
Function module MED	
Order no. 76 0741 00.....	45
Function module FAS	
Order no. 76 0742 00.....	46
Function module VOIP GATE	
Order no. 76 0743 00.....	47
IP-SystemManager	
Order no. 76 2100 00.....	48
Ethernet switch, 8 port	
Order no. 76 4500 00.....	52
Room lamp, 3 sections	
Order no. 77 0170 00.....	53
Room lamp cardiac alarm, WC	
Order no. 77 0170 01.....	54
Room lamp, 4 sections	
Order no. 77 0170 10.....	55
Room lamp, 3 sections, with doorplate	
Order no. 77 0171 00.....	56
Room lamp, 4 sections, with doorplate	
Order no. 77 0171 10.....	57
Room lamp, 3 sections	
Order no. 77 0175 00.....	58
Room lamp cardiac alarm, WC	
Order no. 77 0175 01.....	59
Room lamp, 4 sections	
Order no. 77 0175 10.....	60
Room lamp, 4 sections, C/A/PR/WC	
Order no. 77 0176 00.....	61
Room lamp, 4 sections, C/A/PR/WC	
Order no. 77 0176 01.....	62
Call switch	
Order no. 77 0211 00.....	63
Call switch/WC	
Order no. 77 0211 01.....	64
Staff presence switch	
Order no. 77 0212 00.....	65
Cancel switch/WC	
Order no. 77 0213 00.....	66
Cardiac alarm switch	
Order no. 77 0214 00.....	67

Pull cord call switch	
Order no. 77 0215 00.....	68
Pull cord call switch/WC	
Order no. 77 0215 01.....	70
Pneumatic call switch	
Order no. 77 0216 00.....	72
Pneumatic call switch/WC	
Order no. 77 0216 01.....	74
Call switch/WC with cancel switch	
Order no. 77 0217 00.....	76
Call switch with privacy switch	
Order no. 77 0218 00.....	77
Staff presence combination with call tone	
Order no. 77 0219 00.....	78
IR TV control module universal	
Order no. 77 0360 11.....	79
TV audio amplifier	
Order no. 77 0365 00.....	80
ePat[®]lite	
Order no. 77 0370 00.....	81
ManagementCenter^{PC}	
Order no. 77 0610 00.....	83
PrimusGlobal+ “ManagementCenter”	
Order no. 77 0700 00.....	85
PrimusGlobal+ “Call recording”	
Order no. 77 0710 00.....	87
PrimusGlobal+ “Connect” module	
Order no. 77 0720 00.....	88
PrimusGlobal+ system driver HL7	
Order no. 77 0720 01.....	89
SystemOrganizer	
Order no. 77 0750 00.....	90
OSYlink-Universal	
Order no. 77 0803 00.....	92
OSYlink-Announcement	
Order no. 77 0804 00.....	93
RAN interface	
Order no. 77 0840 00.....	94
OSYlink AS-CCS	
Order no. 77 0870 00.....	96
RAN interface with speech	
Order no. 77 0880 00.....	97
Power supply unit 10 A, DIN rail	
Order no. 77 3410 00.....	98
Power supply unit 5 A, DIN rail	
Order no. 77 3410 50.....	100

UPS Control unit 10A	
Order no. 77 3411 00	102
Battery module	
Order no. 77 3412 00	104
DC-UPS with capacitor storage 24V, 6kWs	
Order no. 77 3413 00	105
iVi™	
Order no. P68005/47	107
MyAmie	
Order no. P68007/02	109
Wireless sensor mat 869 MHz	
Order no. Z 00 8002 01	110
Sensor mat	
Order no. Z 00 8002 02	111
Wireless step-on sensor mat	
Order no. Z 00 8003 0x	112
Large-surface pneumatic switch	
Order no. Z 00 8201 13	113
Large-surface radio pneumatic switch	
Order no. Z 00 8201 15	114
Breathing sensor set	
Order no. Z 00 8201 40	115
Radio receiver-T	
Order no. Z 00 8202 33	116
Radio receiver-T UP	
Order no. Z 00 8202 35	118
Appendix: Services	120
Appendix: Accessories	127

Preliminary notes on Flamenco^{IP+}

1. Introduction

Digitisation does not stop at health care institutions. Previous standalone systems with proprietary interfaces are increasingly being replaced by easily integrated solutions on digital platforms. A combination of different systems and the use of uniform infrastructures allows maximum flexibility and future compatibility in all applications.

Along with open communication, the demand for more security also increases, especially in the context of cyber attacks and the protection of personal data.

Flamenco^{IP+} is the next expansion stage of the Flamenco^{IP} system, which has proven itself in many installations.

The requirements of modern and efficient care organisation can be implemented simply and intuitively with Flamenco^{IP+}. Designed for the future, Flamenco^{IP+} can be securely integrated into existing IT infrastructures with ease. Intelligent adaptations enable straightforward coupling with earlier system generations. Flamenco^{IP+} fulfils all the requirements of a nurse call system according to the German standard DIN VDE 0834 and goes far beyond that standard in terms of security.

The system is intended for use in hospitals, retirement homes and nursing homes, as well as comparable facilities.

Flamenco^{IP+} combines the functions of a modern nurse call system with the possibilities of state-of-the-art value-added solutions to support care processes. Flamenco^{IP+} uses today's technical possibilities and supports every type of care organisation in a simple way, not only with intelligent data networking, but also through existing infrastructures.

Here, the organisation of rooms and their division and allocation into care groups is independent of the selected installation form and infrastructure. This unique separation of physical infrastructure and organisational grouping of rooms permits the largest possible scope in system design and later use.

Based on independently functioning technology, permanent self-monitoring and intelligent networking, Flamenco^{IP+} offers the maximum amount of functional security. A sophisticated security concept ensures a kind of dual protection in case of functional restrictions, failures or malfunctions in the infrastruc-

ture.

Everyday-practical products and easy handling guarantee an efficient support in everyday care. The system is supplemented by extensive interfaces and integration possibilities of legacy systems and third-party equipment.

This allows the system to be tailored to individual requirements in the simplest possible way and set up according to needs.

Voice communication, either system-internally and/or using externally connected telecommunication devices, supports care through excellent voice quality using the latest digital VoIP technology.



2. Standards

The Flamenco^{IP+} nurse call system is designed and manufactured in accordance with ISO 9001 quality standards. All products meet the high requirements for electrical safety and electromagnetic compatibility.

The nurse call system meets the German standard DIN VDE 0834 including the applicable requirements described in the standards. This guarantees the maximum degree of functional and operational safety.

The methods used to ensure transmission and data security comply with legal and normative standards.

3. System structure

The Flamenco^{IP+} system design is logically and partially hierarchically structured. In the rooms, all relevant devices are connected with each other through an intelligent RAN (Room Area Network) system bus and form a functional unit.

All individual devices communicate with each other and form the basis of the nurse call system. Even a call switch and a room lamp are intelligent enough to process messages and at least indicate them on the room lamp.

Even in the event of a fault in the higher-level network or individual control units, the local function remains fully intact. Here, a higher-level control system is not required in the room or elsewhere in the system. The installation in the room can be implemented as a bus, star or mesh.

Starting from the room network, the connection to the next hierarchical level of the system is established through an IP gateway in the ComTerminal^{IP}. These gateways form the connection to the network infrastructure and further to the local organisational group with the assigned system control unit, IP-SystemManager.

In conjunction with a HEALTH or CARE system module, the IP-SystemManager provides a complete nurse call function for an organisational group. Several IP-SystemManagers are connected to each other through an IP network infrastructure, thus forming a complete system.

In the process, the network can be set up exclusively for the nurse call system or as part of the existing IP infrastructure on site as long as the security requirements according to DIN VDE 0834 are observed.

4. Safety according to the German standard DIN VDE 0834

In accordance with the German standard DIN VDE 0834, individual rooms are grouped into organisational groups and controlled and monitored by a local IP-SystemManager. This ensures that, in case of malfunctions, only individual functional units can be disrupted and a total failure is prevented.

For the installation from the ComTerminal^{IP} to the local IP-SystemManager, a separate physical and independent network is required. On-site, general networks may not be used within an organisational group for the nurse call system.

The individual organisational groups, controlled via a

local IP-SystemManager, can subsequently be networked with each other via an existing IP infrastructure. All parts of the system are permanently monitored and any faults are reported via the provided interfaces in order to inform the responsible staff.

The structured system topology of Flamenco^{IP+}, supplemented by permanent system monitoring and automatic error detection, provides a high level of functional and operational safety for the entire system.

5. Cable network

Installation in the room is carried out using standard telecommunication cables, e.g. J-Y(ST)Y 2x2x0.8 mm. Details can be found in the respective planning and installation documents.

The individual IP devices are connected via standardised IP network infrastructures based on structured cabling with data cables from CAT5e; in case of using PoE Ø minimum 0.64 mm (22 AWG).

The power supply for a physical group can either be provided by a system's own, decentralised 24 VDC power supply unit or via a PoE+ infrastructure. The power required to supply the connected devices must be taken into account, as well as cable types, cable lengths and network switches.

If required, a UPS control unit and a battery module or optionally a DC UPS with capacitor storage are available as extension modules for the 24 VDC power supply unit.

The IP-SystemManager and OSYlink interface modules are supplied with 24 V DC from the nurse call system as standard.

6. Mounting and installation

The devices are mounted in standard installation boxes. This ensures individual products can be exchanged at a later date, especially in the room, without having to plan installation boxes with specific dimensions for certain devices in advance.

The products are designed according to the plug-and-play principle and can be used directly without additional assembly or combination. All devices are plug-gable and easy to exchange in case of failure.

7. Peripheral devices in the room

The equipment in the room is designed in plug-and-play technology. Switches and patient devices are easy to clean and disinfect.

The devices can be clearly identified as part of the nurse call system by their shape and colour. Large buttons especially designed for staff guarantee safe operation, especially in an emergency. All displays are designed in energy-saving and durable LED technology.

The room lamp can be customised with a decorative frame as desired by the customer. The structure and design are unique and legally protected.

8. ComTerminal^{IP}

ComTerminal^{IP} is the control centre in the patient's room. It is equipped with all necessary operating and display elements to support the nursing staff. A user-friendly operator interface with a high-resolution colour display, full-touch function and additionally arranged function keys (presence, call initiation) is available for operation.

The surface is made of real glass and allows easy cleaning and disinfection.



Individual performance features and operating modes can be configured and service functions for troubleshooting can be activated via the user interface. The intelligent plug-and-play technology enables simple and safe commissioning.

ComTerminal^{IP} offers excellent voice quality for simple and error-free communication based on modern VoIP technology.

Via a remote update mechanism, the range of functions and features can be adapted and individually extended at any time.

Depending on the model, power is supplied by a conventional 24 VDC supply or by PoE+. The connection to the network is established using appropriate connection terminals.

9. Patient devices

The control devices are designed to meet the special needs of patients and staff. They are characterised by simple operation, easy cleaning and disinfection and are designed for intensive use. Different versions are available for different individual cases, from the simple pear push switch to the multifunctional terminal device ePat^{®lite}.

ePat^{®lite}

ePat^{®lite} is a completely newly developed communication and operating device with intercom technology for use at the patient bed, combined with a remote control for TV, radio, blinds, room and reading light (depending on the availability on-site). The system is operated by means of a touch-sensitive interface.

The call button is connected to the front panel using a seamless, translucent silicone ring and lights up pulsatingly when the call is triggered.

Thanks to the rounded edges on the front and back, the housing concept also allows patients with limited hand motor skills to pick up the device at any time by rocking. The cut-out on the back allows the device to lie securely in the hand. The storage holder allows the unit to be hooked in without exact centring and removed by simply lifting it slightly. The device impresses with its unobtrusive shape, clear symbols and excellent, ergonomic and patient-friendly handling.

Third-party devices

In addition to Tunstall's own equipment, third-party devices can also be used and integrated into the overall system. The open concept allows the use of terminals from various well-known manufacturers, e.g. simple patient telephones with integrated nurse call, LED TV sets or comfort devices with hands-free and special functions. The function of the nurse call

system is independent. This guarantees a very high level of functional reliability of the entire system even in the event of failure and malfunctions, e.g. in the PBX.

In addition to the standard functions of the nurse call, extensive connection and integration options are available.

Application examples (excerpt)

- Switching / dimming of various lighting sources
- Control of bed-related TV sets via special interfaces
- Control of commercially available TV sets via infrared
- Connection of external sensors, e.g. alarm mats

9. Corridor display^{IP} Alpha 16

Corridor displays in IP technology are available for displaying patient calls and additional information. The single-sided version is intended for wall mounting. The double-sided version is intended for ceiling mounting.

The corridor displays provide 16 alphanumeric characters using red LEDs. Longer texts are displayed as tickers. The display can automatically switch to a scrolling mode to show information waiting in parallel, e.g. several simultaneous calls. The display contents themselves can be configured in the system.

For the transmission of announcements, two loudspeakers are integrated in the corridor display and are driven by the nurse call system via the network using VoIP. The volume can be adjusted in three levels via the system.

Power is supplied by a conventional 24 VDC supply or by PoE+, alternatively. The corridor display has a RJ45 socket and is connected to the network with a patch cable.

The display can also be read at a greater distance thanks to the clear and bright writing.

11. Ward console ComStation^{IP}

The ward console ComStation^{IP} for the nurse station is an IP telephone with 7" touch display. Equipped with all functions for handling calls, triggering announcements, organising the ward and displaying all important operating states.

The user interface is intuitive and safe to use thanks to clear symbols and simple operating procedures.

The connection can be plugged into the existing IP infrastructure. The power supply is device-specific.



The ComStation^{IP} is designed for both desktop and wall mounting. Equally suitable.

The ComStation^{IP} serves to ensure the safety of patients and staff and to provide optimum support for the care organisation.

12. ManagementCenter^{PC}

Central console as PC workstation for the organisation of a complete building or individual sections. With the management and organisation software PrimusGlobal+ and the flexibly configurable operating modes, any type of organisational form can be supported. Simple call answering, the display of staff presences and extensive options for announcements, searches and alertings allow a constant and updated overview of what is happening in the entire building. This transparency creates the conditions for safe action and short reaction times, especially in emergencies. Extensive software modules are available for the various organisational and maintenance tasks and can be supplemented at any time.

13. Interfaces

The Flamenco^{IP+} system is equipped with extensive interfaces. Specially adapted interface modules are available for each application. Whether a decentralised or central location – always where they are needed. Local contact inputs and contact outputs on the ward are provided by OSYlink modules. The connection is made directly through an intelligent bus on the IP-SystemManager. The integration of announcements and the connection of external systems is therefore possible with ease.

For data exchange with external systems, simple serial interfaces or contact modules are available in addition to network-based software interfaces.

Depending on the application, communication with other systems takes place directly through one of the decentralised IP-SystemManagers or through an additional centrally installed IP-SystemManager. The available serial and LAN-based interfaces can be used for different applications. For this purpose, IP-SystemManagers can be supplemented with various paid software modules.

The coupling of telephone systems or the installation of messaging services is also possible. A wide range of different applications is available. The transparent system structure enables SIP/VoIP connections or simple messaging.

Exemplary interfaces (excerpt)

- PABX connection
- Data output to building management solutions
- Fire alarm system connection
- Telemetry system connection

Additional connections are possible.

14. System security

The security concept of Flamenco^{IP+} is based on a modern, standalone, independent and self-monitored system platform. Thanks to the hierarchical system structure, the basic function of the nurse call system is always maintained even if systems and components connected through interfaces fail.

The functional safety applies to the entire system and is not limited to ward related functions. If individual components of the nurse call system fail, a minimum function is always ensured. In critical cases, when a call is triggered, at least the room lamp is switched on to clearly identify call triggering location.

All relevant system data is permanently protected against power failure and configuration data is stored redundantly in the system.

To ensure functional and operational safety, each organisational group works independently and autonomously on the basis of the IP-SystemManager.

Note on the responsibility of the system owner

Especially when using existing networks on-site, their operational safety is the sole responsibility of the

owner, who must establish a safe connection between the products of the nurse call system and the network and check them regularly to ensure their integrity and functional safety.

Appropriate measures (e.g. installation of firewalls, use of authentication measures, data encryption, installation of anti-virus programs, etc.) must be taken to protect the products, the network, the system and the interfaces against all types of security breaches, unauthorised access, interference, intrusion attempts, information leakage and/or theft of data or information. Tunstall GmbH is not liable for damages and/or losses in connection with security breaches, unauthorised access, malfunctions, intrusion attempts, information leaks and/or the theft of data or information. The requirements for a network for the use of a nurse call system must be observed and form the basis for smooth operation. An appropriate information document is available if required.

15. System care

Thanks to the plug-and-play technology used, especially in the room area, system maintenance is extremely simple and cost-saving. No special expertise or tools are required for the normal replacement of components.

Flamenco^{IP+} is permanently self-monitored and can be centrally configured and maintained. These tasks can be performed locally on site or via remote access.

A specially developed tool, the SystemOrganizer, is available for system configuration. This tool can be used as early as the system planning phase. The user is able to change any setting on the system and adjust it according to his or her needs. Access to the system is via graded authorisations with password protection and secure connections to prevent unwanted configuration changes.

17. System supplements

The system functions and the scope of functions of Flamenco^{IP+} can be adjusted at any time if new functions or service updates are available. This includes both the system core and the software modules for various products. Additional products and solutions can be added or replaced by other variants at any time. Changes to the system configuration are also possible at any time.

Exemplary system additions

- Care system for patients suffering from dementia
- Wireless call devices from the extensive Tunstall portfolio
- Extensive range of accessories for special call devices
- Call logging and documentation of all events
- Extensive interfaces to external systems
- Software modules for various applications
- Personal protection for staff and patients/residents (mobile call)

18. Compatibility

The Flamenco^{IP+} system is equipped with special features and interface modules for the renewal of old installations. Thanks to the cable-saving technology in the room, the existing infrastructure can be used in many cases. This includes both the installation cables and existing bus cables as well as the back boxes used.

Note! Not all system generations can be connected. Each connection must be checked in advance in each individual case.

Coupling to third-party systems is also possible via simple contact modules. For Tunstall-owned predecessor systems, extensive installation aids and special interfaces are also available. Previous systems of the last generations can be integrated into the new IP infrastructure of Flamenco^{IP+} via special adapters and combine several system generations as a complete system.

18. Services

In addition to the integrated service tools, additional services can be offered for a fee.

- Application consulting for equipment planning
- Support in system planning and system design
- Customer-specific system configuration
- Remote access for further services
- Inspection, maintenance and repair
- Software support contracts to maintain system integrity
- Regular functional enhancements
- Error analyses
- Extensive system training

Other services on request.



19. Software modules, rights of use

Flamenco^{IP+} offers all basic functions of a nurse call system according to DIN VDE 0834 and, in addition, further functional supplements and extensions. Extensive software in the form of system and function modules is available for this purpose. These modules can be installed and used on the IP-System-Managers.

To maintain the up-to-dateness of the system and the software modules used, the conclusion of a software support contract is recommended for all system and function modules. The annual costs incurred include regular software maintenance in the form of security updates to ensure system integrity.

21. Summary

The Flamenco^{IP+} system represents a state-of-the-art, flexible communication instrument that can be adapted to the concerns of the organisation of modern care. Even in case of complex integration with other systems, the nurse call system remains an autonomous unit.

All parts of such a complex system structure can be maintained or modernised separately from and independently of each other or replaced by other state-of-the-art solutions. This guarantees high functional safety and prevents a mutual influencing of the subsystems. This means that if PBX, IT/IP networks, television systems or other interfaces fail, the nurse call

system still functions autonomously.

Flamenco^{IP+} offers a maximum of planning freedom, investment security and future orientation.

The open architecture enables later and simple system expansion with e.g. cordless phones to support care management and care processes or multimedia end devices at the patient bed.

Loudspeaker with announcement interface

wall mounted loudspeaker

05 0024 02



General description

Wall mounted speaker in a full metal design suitable for announcements of the nurse call system.

Designed for installation in corridors and large rooms.

Adjustable amplifier for announcements from the nurse call system.

Transformer for entertainment transmission.

Specification

- Full metal design
- Vandal-proof
- Extremely stable metal housing with corrosion-resistant powder coating
- Compliant with:
 - EN 54-24:2008 part 24
 - British Standard BS 5839, part 8
- Connection via screw terminals
- Adjustable amplifier for announcements
- Transformer for entertainment transmission

Technical data (electrical)

Power:	10/6/3/1.5 W
Frequency range:	170 – 18500 Hz
Sound pressure level (without announcement interface):	
- 1 W / 1 m, peak:	98.3 dB
- 1 W / 4 m, peak:	86.3 dB
- P _{max} / 4 m, peak:	94.0 dB
Power supply:	24 V DC
Standby current consumption:	80 mA

Technical data (mechanical)

Dimensions (HxWxD):	193 x 253 x 82 mm
Weight:	2.2 kg
Ingress protection code:	IP21
Ambient temperature:	+5 °C to +40 °C
Housing material:	Metal
Colour:	RAL 9010, pure white

Order no.	Product name	Note
05 0024 02	Loudspeaker with announcement interface	wall mounted loudspeaker

Loudspeaker set with announcement interface

ceiling-mounted loudspeaker

05 0024 03



General description

Big, high efficiency, ceiling-mounted loudspeaker suitable for announcements of the nurse call system. Designed for installation in corridors and large rooms.

Adjustable amplifier for announcements from the nurse call system.

Transformer for entertainment transmission.

Specification

- 200 mm full-range loudspeaker chassis
- Mounting with 3 spring clamps
- Adjustable amplifier for announcements
- Transducer for entertainment transmission
- Steel loudspeaker frame included with delivery
- Compliant with:
 - EN 54-24:2008
 - British Standard BS 5839, part 8
- Steel loudspeaker frame: Fire-resistance class F30 acc. to German standard DIN 4102-2
- Connection with screw terminals

Technical data (electrical)

Power:	6/3/1.5 W
Frequency range:	326 – 19200 Hz
Sound pressure level (without announcement interface):	
- 1 W / 1 m, peak:	102.0 dB
- 1 W / 4 m, peak:	90.0 dB
- P _{max} / 4 m, peak:	97.7 dB
Power supply:	24 V DC
Standby current consumption:	80 mA

Technical data (mechanical)

Diameter:	267 mm
Height:	135.5 mm
Weight:	2.36 kg
Ceiling cut-out:	243 mm
Ingress protection code:	IP55
Temperature range:	-10 °C to +55 °C
Material:	Metal
Colour:	RAL 9010, pure white

Order no.	Product name	Note
05 0024 03	Loudspeaker set with announcement interface	ceiling-mounted loudspeaker

Loudspeaker set

ceiling-mounted loudspeaker

05 0024 04



General description

Big, high efficiency, ceiling-mounted loudspeaker suitable for announcements of the nurse call system. Designed for installation in corridors and large rooms.

Specification

- 200 mm full-range loudspeaker chassis
- Mounting with 3 spring clamps
- Steel loudspeaker frame included with delivery
- Compliant with:
 - EN 54-24:2008
 - British Standard BS 5839, part 8
- Steel loudspeaker frame: Fire-resistance class F30 acc. to German standard DIN 4102-2
- 2-pin ceramic block

Technical data (electrical)

Power:	6/3/1.5 W
Frequency range:	326 – 19200 Hz
Sound pressure level (without announcement interface):	
- 1 W / 1 m, peak:	102.0 dB
- 1 W / 4 m, peak:	90.0 dB
- P _{max} / 4 m, peak:	97.7 dB

Technical data (mechanical)

Diameter:	267 mm
Height:	135.5 mm
Weight:	2.06 kg
Ceiling cut-out:	243 mm
Ingress protection code:	IP55
Temperature range:	-10 °C to +55 °C
Material:	Metal
Colour:	RAL 9010, pure white

Order no.	Product name	Note
05 0024 04	Loudspeaker set	ceiling-mounted loudspeaker

Pull cord call switch insert

without frame

29 0707 20F

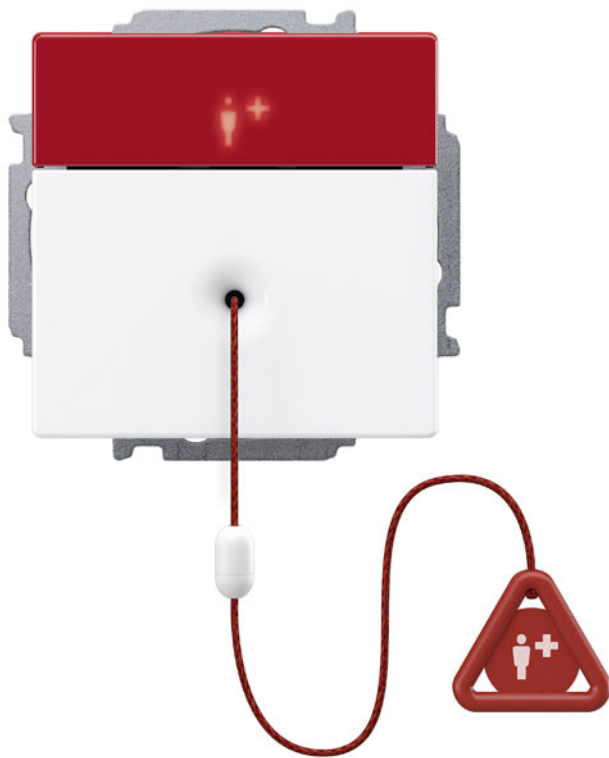

General description

Switch insert with a pull cord at the end of which a call handle is attached, for triggering calls or WC calls by pull actuation. Another call option is a red call button with reassurance light.

Particularly suitable for triggering calls in the shower or next to the WC.

The reassurance light illuminates brightly as soon as a call is raised. If presence in the room is switched on when a call is raised, an emergency call is triggered.

Cancel function for WC calls optionally configurable.

Suitable for wall and ceiling mounting.

Specification

- 2.50 m long pull cord incl. call handle with symbol and safety release
- Safety release in the pull cord opens when the pulling force exceeds a limit value of approx. 25 Nm (strangulation protection). The safety release is closed again by simply plugging it together.
- Red call button with reassurance light and integrated location light
- Acoustic feedback for call activation
- Usable for call (factory setting) or WC call
- The pull cord switch can be configured in such a way that WC calls can not only be raised but also cancelled with activated staff presence using the pull cord (Function available from production week 24/2021). To comply with DIN VDE 0834, an additional cancel switch must be installed.
- A channel number can be set on the pull cord switch to specify the call location in the room in more detail. The channel number can, for example, identify beds or WC cubicles.
- Standard set to channel 0
- Identifiable as part of the nurse call system through design features
- Easy plug-and-play mounting
- Wall mounting or ceiling mounting in 1-gang back box
- Mounting in single frame
- Integrated electronics with 3-pole plug connection for the room bus (RAN)

Pull cord call switch insert

without frame

29 0707 20F

- Page 2 -



Scope of supply

- Pull cord switch insert
- Mounting plate
- Terminal block, 5-pole, black/yellow/red/light grey/dark grey, plugged in
- Installation instructions

Technical data

Nominal voltage:	24 V DC
Standby current consumption:	9 mA
Degree of protection:	IP22
Dimensions (HxW):	71 x 71 mm
Installation depth:	24 mm
Housing material:	Polycarbonate
Pull cord material:	Polyamide
Call handle material:	ABS
Ambient temperature:	+5 °C – +40 °C
Relative humidity:	0 % – 95 %

Order no.	Product name	Note
29 0707 20F	Pull cord call switch insert	Design future® linear
Frame, order separately:		
77 0210 51	Frame A, 1-gang	
77 0210 52	Frame C, 1-gang	
77 0210 52	Frame F, 1-gang	
Necessary accessories, order separately:		
17 0100 00	Back box solid wall, 1-gang	see appendix "Accessories"
17 5100 00	Back box partition wall, 1-gang	see appendix "Accessories"
Spare parts, reorder if required:		
19 9500 19	Terminal block, 5-pole, bk/ye/rd/gy/gy	see appendix "Accessories"
77 9510 06	Pull cord incl. call handle, safety release	see appendix "Accessories"

PrimusGlobal module Building Services

45 1400 00

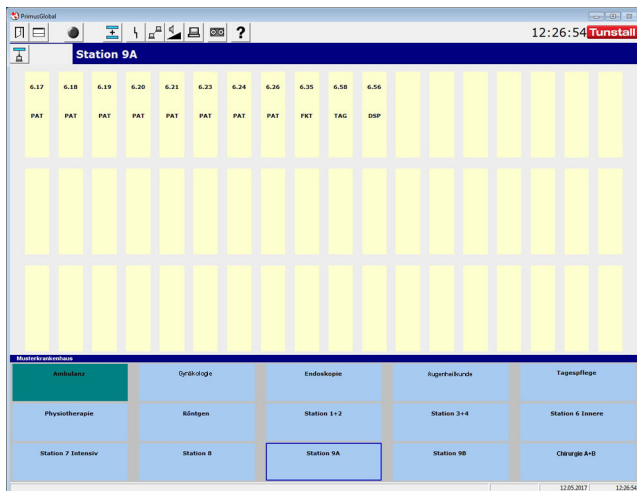

General description

The PrimusGlobal software family is an effective supplement for nurse call systems of the Flamenco system family. The module Building Services is a supplement to the basic package.

To support the building services an information service displays all nurse call system events. Graphical interface using block graphics.

Specification

- Displayed data are taken from the nurse call system
- Visualisation in block graphics
- Parallel display of system messages, system status, and fault messages

System requirement

- Existing installation of PrimusGlobal+ “Call recording”, e.g. in the form of “Call recording Flamenco, complete set”

Order no.	Product name	Note
45 1400 00	PrimusGlobal module Building Services	
System requirement, order separately:		
50 1027 00	Call recording Flamenco, complete set	see appropriate data sheet
Required service, order separately:		
77 0790 00	PrimusGlobal+ System set-up & configuration	see appendix “Services”

Call recording Flamenco, complete set

50 1027 10

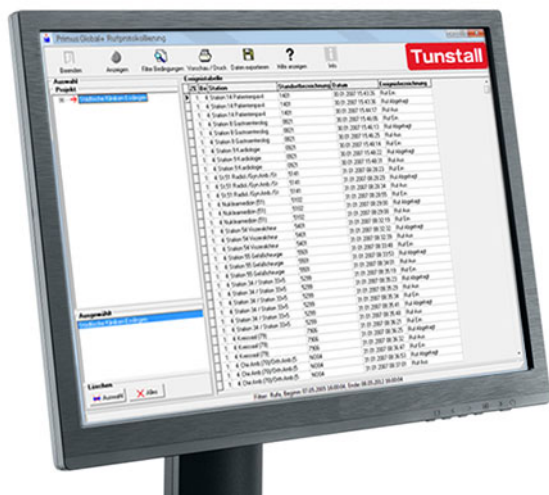

General description

The complete set Call Recording Flamenco is used to support the care documentation. All call data, staff registrations and system events are recorded. Data storage is effected with date, time plus relevant information as to the data source such as ward and room.

Filtering and sorting of data can be selected for numerous combinations of criteria. For succeeding post-processing and analysis there is an export function to convenient office applications.

Connection to the nurse call system's IP network.

Components

- System computer (order no. 80 6010 00D)
- LCD monitor 19" (order no. 80 6049 00)
- UPS 600 VA/360 W (order no. 21 9000 00)
- PrimusGlobal+ "Call recording" (order no. 77 0710 00)

Features

- Permanent recording of all system events
- Selection of locations (wards, rooms, etc.) to analyse
- Filtering data according to event time
- Filtering data according to event type (calls, presences, other events)
- Filtering data according to actions taken
- Selection of parameters for display
- Sorting the data
- Print feature
- Export feature to convenient office packages, CSV format.

Software support contract

The acquiring of the system software PrimusGlobal+ is combined with placing of a software administration contract with costs. The administration contract is an important prerequisite for an optimal and long-term use of the user software

Scope of services:

- Regular updates of PrimusGlobal+ software
- Revisions in configuration and adaptations to ongoing developments
- Remote maintenance: Comfortable error analysis and correction online
- Telephone hotline during business hours of Tunstall GmbH

Order no.	Product name	Note
50 1027 10	Call recording Flamenco, complete set	English language

Universal sensor

for use with radio receiver-T and -T UP

61005/30



Basic properties

- Radio range depending on the building structure:
 - to home unit: up to 50 m
 - to radio receiver-T or -T UP: up to 30 m
 - to CareAssist: up to 50 m
- Four buttons and LCD screen for easy configuration
- Battery operation
- Expected life of the replaceable battery is approximately 5 years under normal conditions.
- Signalling when the battery of the universal sensor is low:
 - The home unit automatically triggers a background call to the monitoring centre.
 - The LED on the radio receiver-T or -T UP flashes red.
 - The CareAssist alerts the user with a transmitter battery low message

General description

Universal sensor for use with the following Tunstall products:

- All current home units
- All radio receivers-T and -T UP
- CareAssist

Available operating modes

- Forwarding the alarms of wired telecare sensors
- Use as door guard for call activation
- Use as door contact for event message
- Use as bed/chair occupancy sensor for call activation
- Use as virtual bed sensor for event message

The universal sensor is configured for the desired operating mode using four built-in buttons and an LCD screen.

Forwarding the alarms of wired telecare sensors

- This operating mode is available with home units, radio receiver T and -T UP, CareAssist
- Normally closed and normally open contacts (potential free) can be connected
- Connection to the free wire ends of the 195 cm long connection cable with RJ11 plug. Connection to the 3.5 mm jack socket as an option.

Universal sensor

for use with radio receiver-T and -T UP

61005/30

- Page 2 -



- The universal sensor is able to transmit the following call types to home units and to the CareAssist:
 - CO detected
 - Enuresis
 - Epilepsy
 - Natural gas
 - Pendant (personal trigger) activated
 - Smoke detected
- Attention! Radio receivers-T and -T UP forward calls from the universal sensor without specifying the call type. The call type displayed in the nurse call system depends on the configuration in the nurse call system
- The universal sensor will be assigned to the home along with the call type via Plug&Play

Use as door guard for call activation

- This operating mode is available with home units. It is not available with radio receiver T, -T UP or CareAssist
- The magnetic contacts delivered with the universal sensor are used and connection to the RJ11 input.
- A property exited alarm is generated when the door is opened.

Use as door contact for event message

- This operating mode is available with home units supporting the virtual property exit feature, e.g. Lifeline Vi+.
- This operating mode is not available with radio receiver T, -T UP or CareAssist.
- Usage for monitoring the well-being, to indicate the door open/close activity.
- The magnetic contacts delivered with the universal sensor or the built-in reed switch are used
- When the door is opened an event message “door opened” will be generated. No call activation.
- When the door is closed an event message “door closed” will be generated. No call activation.

Use as bed/chair occupancy sensor for call activation

- This operating mode is available with home units as well as with radio receiver T and -T UP. This operating mode is not available with CareAssist.
- Bed pad or chair pad required as accessory
- The pad is connected to the RJ11 socket of the universal sensor
- An alarm is generated if a user has got out of their bed/chair during a monitoring time window (e.g. night) and has not returned within the pre-configured absence time period.
- An alarm is generated, is not in bed by a pre-configured time.
- An alarm is generated, is not out of bed by a pre-configured time.

Universal sensor

for use with radio receiver-T and -T UP

61005/30

- Page 3 -



- When the user has got out of bed an event message “out of bed” will be generated. No call activation.

Technical data

Dimensions (HxWxD):	80 x 50 x 25 mm
Weight (incl. battery):	75 g
Connection cable:	approx. 200 cm
Magnet dimensions (HxWxD):	68 x 15 x 12 mm
Magnet switch dimensions (HxWxD):	68 x 15 x 12 mm
Housing colour:	white
Battery type:	AA 3.6 V
Radio frequency:	869.2125 MHz
Ambient temperature:	
- Operation	0 °C to 45 °C
- Storage, Transport	-10 °C to 50 °C

Use as virtual bed sensor for event message

- This operating mode is available with home units supporting the virtual occupancy sensor feature, e.g. Lifeline Vi+.
- This operating mode is not available with radio receiver T, -T UP or CareAssist.
- Usage for monitoring the well-being, to indicate the sleep pattern.
- Bed pad or chair pad required as accessory
- The pad is connected to the RJ11 socket of the universal sensor
- When the user has got in bed an event message “in bed” will be generated. No call activation.

Order no.	Product name	Note
61005/30	Universal sensor	
Use with radio receiver-T and -T UP -T UP:		
Z 00 8202 33	Radio receiver-T	
Z 00 8202 35	Radio receiver-T UP	
Accessories, order if required:		
D4106009A	Bed pad	for single bed. 2 required for double bed.
D4106010A	Chair pad	

Connection socket with call switch, bedhead unit

70 0171 50

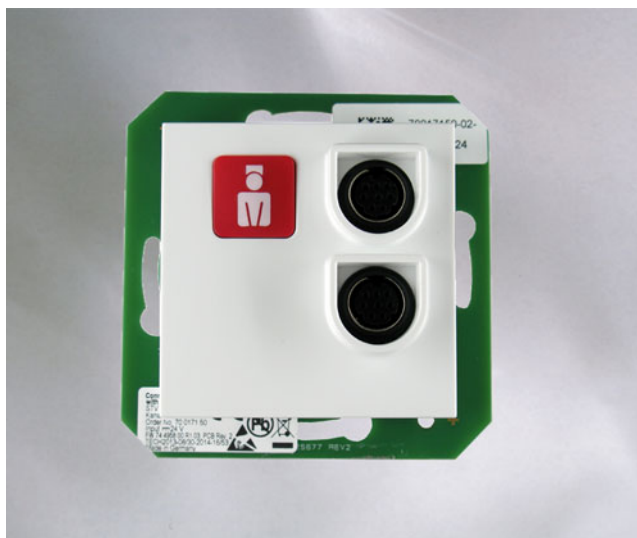

General description

Connection socket including 2 sockets for the connection of call devices, e.g. pear push switch.

Designed for mounting in medical supply unit. Backside mounting.

One call button for patient and staff use complete with integrated reassurance light. The reassurance light illuminates upon activation of a call.

The special design indicates the connection socket also optically as part of the nurse call system.

Specification

- 1 red call button with reassurance light and integrated night location light
- 2 identical sockets for the connection of pear push switches or similar equipment
- 1 backside connection to an additional call button with location and reassurance light. Normally closed or normally open contact can be set by DIP switch
- Integrated disconnection call
- Bed identification
- Plug installation for easy mounting
- Standard set to channel 0
- 2 switching outputs for light switching: 24 V DC, 200 mA max.
- Integrated electronic processor for connection to the room bus (RAN)

Technical data

Dimensions (HxWxD):	70,5 x 70,5 x 41 mm
Power supply:	24 V DC
Standby current consumption:	21 mA
Colour:	Studio white, similar to 9016
Housing material:	Polycarbonate
Material of the call button:	Front: Polycarbonate Housing: PBT

Order no.	Product name	Note
70 0171 50	Connection socket with call switch, bedhead unit	as described above
Necessary accessories, order separately:		
00 0211 37	Connector, 5-pole	see appendix "Accessories"
Optional accessories, order if required:		
50 0308 02	Connection cable	for an additional external call device
19 9102 40	Button cap white, call button	see appendix "Accessories"

Connection socket with call switch

70 0171 60...



70 0171 60 A

General description

Connection socket including 2 sockets for the connection of call devices, e.g. pear push switch.

Designed for wall mounting.

One call button for patient and staff use complete with integrated reassurance light. The reassurance light illuminates upon activation of a call.

The special design indicates the connection socket also optically as part of the nurse call system.

Specification

- 1 red call button with reassurance light and integrated night location light
- 2 identical sockets for the connection of pear push switches or similar equipment
- 1 backside connection to an additional call button with location and reassurance light. Normally closed or normally open contact can be set by DIP switch
- Integrated disconnection call
- Bed identification
- Plug installation for easy mounting
- Standard set to channel 0
- 2 switching outputs for light switching: 24 V DC, 200 mA max.
- Integrated electronic processor for connection to the room bus (RAN)
- Attractive Design Frame

Technical data

Power supply:	24 V DC
Standby current consumption:	21 mA
Colour:	Studio white, similar to 9016
Material:	Polycarbonate
Material of the call button:	Front: Polycarbonate Housing: PBT

Order no.	Product name	Note
70 0171 60 A	Connection socket with call switch	Dimensions (HxWxD): 91 x 91 x 41 mm
70 0171 60 C	Connection socket with call switch	Design frame made of white glass Dimensions (HxWxD): 107 x 107 x 41 mm
70 0171 60 F	Connection socket with call switch	Dimensions (HxWxD): 80 x 80 x 41 mm
Necessary accessories, order separately:		
17 0100 00	Back box solid wall, 1-gang	see appendix "Accessories"
17 5100 00	Back box partition wall, 1-gang	see appendix "Accessories"
00 0211 37	Connector, 5-pole	see appendix "Accessories"
Optional accessories, order if required:		
50 0308 02	Connection cable	for an additional external call device

Connection socket combi

studio white

70 0425 00



General description

Combined connection socket with two different sockets for connection of patient units and/or call devices.

Intended for the following functions: transmission of calls, control of 2 light sources, TV transmission, transmission of entertainment programmes, and blinds control.

Preferably designed for wall mounting.

Specification

- 2 different sockets for use either individually or simultaneously
- 1 socket for the connection of an ePat^{®lite} or a patient handset, 13-pole
- 1 socket for connection of a call device, 8-pole (e.g. pear push switch)
- Integrated disconnection call

- The two outputs for light control provide a 24 V signal for the length of time the light switch on the ePat^{®lite}, patient handset or pear push switch incl. call and light switch remains pressed. The outputs may be loaded with 60 mA.
- The dimming feature requires suitable dimmable ballasts, e.g. with DALI interface.
- Connection possibility for 5 entertainment programmes
- Connection possibility for blinds control
- Entertainment and blinds control are available with ePat^{®lite}. Entertainment or blinds control are available with patient handset.
- In case of blinds control transmission of the control signals via RAN interface universal, order no. 70 0848 00
- Connection for TV tone
- TV control in combination with RAN interface, order no. 77 0840 00.
- TV tone/Entertainment input: 25 V_{eff}
- Standard set to channel 3 (i.e. bed 3)
- Jumper for setting the bed number 0.55 – 1 mm Ø
- Coding switch for setting the bed number

Technical data

Dimensions (HxWxD):	90 x 181 x 10 mm
Power supply:	24 V DC
Standby current consumption:	30 mA
Colour:	Studio white, similar to 9016
Material:	Polycarbonate

Order no.	Product name	Note
70 0425 00	Connection socket combi, Studio white	as described above
Necessary accessories, order separately:		
17 0410 00	Back box solid wall, 2-gang	see appendix "Accessories"
17 5400 00	Back box partition wall, 2-gang	see appendix "Accessories"

Connection socket combi, bedhead unit

studio white

70 0435 00

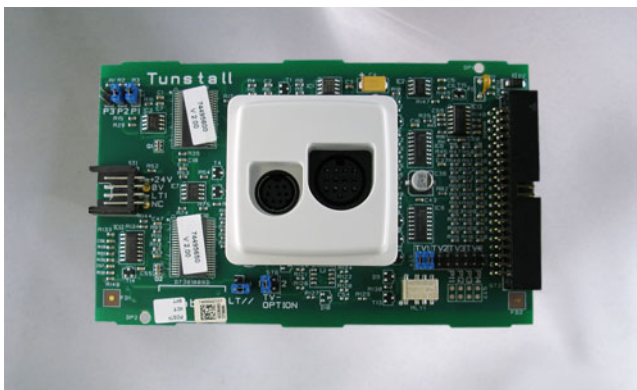

General description

Combined connection socket with two different sockets for connection of patient units and/or call devices.

Intended for the following functions: transmission of calls, control of 2 light sources, TV transmission, transmission of entertainment programmes, and blinds control.

Preferably designed for mounting in medical supply units.

Specification

- 2 different sockets for use either individually or simultaneously
- 1 socket for the connection of an ePat^{®lite} or a patient handset, 13-pole
- 1 socket for connection of a call device, 8-pole (e.g. pear push switch)
- Integrated disconnection call
- The two outputs for light control provide a 24 V signal for the length of time the light switch on the ePat^{®lite}, patient handset or pear push switch incl.

call and light switch remains pressed. The outputs may be loaded with 60 mA.

- The dimming feature requires suitable dimmable ballasts, e.g. with DALI interface.
- Connection possibility for 5 entertainment programmes
- Connection possibility for blinds control
- Entertainment and blinds control are available with ePat^{®lite}. Entertainment or blinds control are available with patient handset.
- In case of blinds control transmission of the control signals via RAN interface universal, order no. 70 0848 00
- Connection for TV tone
- TV control in combination with RAN interface, order no. 77 0840 00.
- TV tone/Entertainment input: 25 V_{eff}
- Standard set to channel 3 (i.e. bed 3)
- 40-pole connection block for internal connection within the medical supply unit
- Connection via a 40 pole flat cable
- 4-pole connector for reading light control
- Jumper for setting the bed number

Technical data

Dimensions (HxWxD):	81 x 131 x 37 mm
Power supply:	24 V DC
Standby current consumption:	30 mA
Colour:	Studio white, similar to 9016
Material:	Polycarbonate

Order no.	Product name	Note
70 0435 00	Connection socket combi, bedhead unit, Studio white	as described above

Pear push switch

for connection socket 700xxxxx

70 071x 0x



Pear push switch incl. call and light switch



Pear push switch incl. 2 call switches

General description

Pear push switch incl. call and light switch: Humidity protected call and light switch for activation of calls and reading light control.

Pear push switch incl. 2 call switches: Humidity protected call switch for activation of calls.

Integrated reassurance light for indicating an activated call.

Plug-in connection to a connection socket, order no. 70 0xxx xx, socket for pear push switch.

Specification

- Ergonomic switches designed to facilitate easy operation and for the prevention of unintentionally initiated calls
- Compact housing providing moisture protection and enabling easy cleaning and disinfecting
- Pear push switch incl. call and light switch:
 - Red call button with reassurance light and integrated night location light, red LED;
 - Button for reading light control
- Pear push switch incl. 2 call switches:
 - 2 red call buttons with reassurance light and integrated night location light, red LED
- Connection cable with robust plug according to DIN 41524.

Technical data

Dimensions (HxB):	60 x 20 mm
Power supply:	24 V DC
Colour:	RAL 9018 papyrus white
Housing material:	ABS
Material of the buttons:	Thermoplastic elastomer
Connection cable:	Soft PVC

Order no.	Product name	Note
70 0710 00	Pear push switch incl. call and light switch, 2 m	approx. 2 m connection cable
70 0710 01	Pear push switch incl. call and light switch, 4 m	approx. 4 m connection cable
70 0711 00	Pear push switch incl. 2 call switches, 2 m	approx. 2 m connection cable
70 0711 01	Pear push switch incl. 2 call switches, 4 m	approx. 4 m connection cable

Pear push switch

for connection socket 70017150/60

70 0712 00



General description

Water protected call and light switch for activation of calls and for reading light and room light control.

Connection to a connection socket, order no. 70 0171 50 or 70 0171 60...

Specification

- Red call button with reassurance light and integrated night location light as LED
- 3 tactile locating points on the call button
- Two yellow light buttons
- Clear identification through symbols
- Disconnection call
- Easy cleaning and disinfection due to water-protected, closed housing
- Protected against temporary immersion in water and dust-tight (IP67)
- Approx. 3 m flexible connection cable with plug

Technical data

Dimensions (HxWxD):	70 x 35 x 10 mm
Weight:	approx. 150 g
Colour:	white, similar to 9010
Power supply:	24 V DC
Standby current consumption:	0.7 mA
Ingress protection code:	IP67
Housing material:	ABS
Material of the buttons:	Hard coated polyester film
Connection cable:	Soft PVC

Order no.	Product name	Note
70 0712 00	Pear push switch incl. call & 2 light switches, 3 m	
Necessary accessories, order separately:		
70 0171 50	Connection socket with call switch, bedhead unit	see appropriate data sheet
70 0171 60...	Connection socket with call switch	see appropriate data sheet

Sound detector

for connection socket 700xxxxx

70 0790 01



General description

The sound detector registers the noises produced by the patient as call and then initiates a call in the nurse call system. Furthermore a call can be initiated by pressing the red call button on the unit.

There are several operation indicators and adjustment possibilities.

Plug-in connection to a connection socket, order no. 70 0xxx xx, socket for pear push switch.

Specification

- Microphone sensitivity adjustable
- Noise filtering adjustable
- LED call indicator (orange)
- LED microphone status (green)
- Call button (red) for manual raising of calls
- Disconnection monitoring
- Microphone ON/OFF switch (grey)
- Microphone
- Approx. 2 m flexible cable with plug for connection to a connection socket of the nurse call system, socket for pear push switch

Technical data

Dimensions (DxHxH):	110 x 20 x 50 mm
Power supply:	24 V DC
Standby current consumption:	30 mA
Microphone sensitivity:	-38 +/- 3dB
Ingress protection code:	IP30

Order no.	Product name	Note
70 0790 01	Sound detector	as described above

Connector interface module

70 0834 00

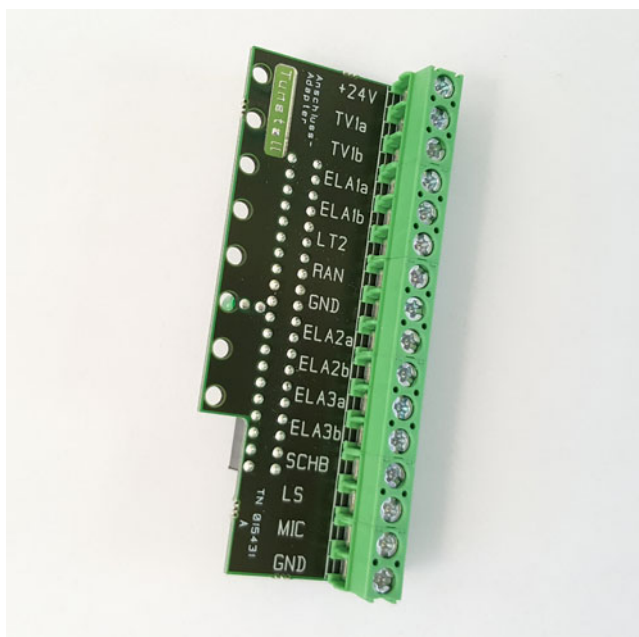

General description

16-pole plug-in adapter for use in conjunction with connection socket combi, bedhead unit, order no. 70 0434 00 or 70 0435 00.

The connector interface module converts the 40-pin ribbon cable connector to a screw terminal block, allowing the termination of regular cabling.

Designed for system renewal in medical supply units.

Connection options

- Room bus RAN
- 3 entertainment sound channels
- 1 TV sound channel
- 24 V DC power supply
- Speech communication
- Output for light control

Order number	Product name	Notes
70 0834 00	Connector interface module	as described above

Corridor display^{IP} Alpha 16

76 0150 00



- Additional display of presences and faults optional (configuration per ward)
- Call tone for acoustic signalling of calls
- Call tone volume adjustable (soft, medium, loud) (configuration per ward).
- Call tone output can be switched off on the unit
- Announcement transmission can be switched off on the unit
- Display of the time in idle state (can be switched off on the unit)
- Direct connection to the IP network of the nurse call system, RJ45 socket on the unit
- Power supply via PoE+ or via separate 24 V DC supply (2-pole screw connector)
- Reverse polarity protection, over-voltage protection
- "Keyholes" for wall mounting

General description

Display for alphanumeric display of calls and general system information in Flamenco^{IP+} nurse call systems. Tone generator for acoustic signals. Two loudspeakers for announcements.

Designed for installation in corridors or staff rooms. Direct connection to the IP network of the nurse call system.

Specification

- 16 alphanumeric
- Text height 50 mm, luminous colour: Red
- LEDs with ambient light dependent luminosity, automatic adjustment
- Display of fresh calls. Additional display of answered calls optional (configuration per ward)
- Display of room as call location. Additional display of the ward optional (configuration per ward)
- Longer texts are automatically displayed as ticker
- Steady display of the highest priority call or as an option: Scrolling display of several calls (configuration per ward)

Technical data

Dimensions (HxWxD):	125 x 785 x 55 mm
Weight:	approx. 1800 g
Housing material:	Aluminium, lacquered, with end caps made of ABS, lacquered
Front window material:	Acrylic glass
Housing colour:	RAL 9003, signal white
Ingress protection code:	IP20
Current consumption:	
- in standby:	130 mA at 24 V DC
- on call:	440 mA at 24 V DC
Power consumption:	
- in standby:	3.8 W at PoE+
- on call:	12.0 W at PoE+
Ambient temperature:	+5 °C to +40 °C
Relative humidity:	0 % to 85 % (non-condensing)

Order no.	Product name	Note
76 0150 00	Corridor display ^{IP} Alpha 16	single-sided version

Corridor display^{IP} Alpha 16, double-sided

76 0160 00



General description

Double-sided display for alphanumeric display of calls and general system information in Flamenco^{IP+} nurse call systems. Tone generator for acoustic signals. Two loudspeakers for announcements.

Designed for installation in corridors or staff rooms. Direct connection to the IP network of the nurse call system.

Specification

- 16 alphanumeric
- Text height 50 mm, luminous colour: Red
- LEDs with ambient light dependent luminosity, automatic adjustment
- Display of fresh calls. Additional display of answered calls optional (configuration per ward)
- Display of room as call location. Additional display of the ward optional (configuration per ward)
- Longer texts are automatically displayed as ticker
- Steady display of the highest priority call or as an option: Scrolling display of several calls (configuration per ward)
- Additional display of presences and faults optional (configuration per ward)
- Call tone for acoustic signalling of calls
- Call tone volume adjustable (soft, medium, loud) (configuration per ward).
- Call tone output can be switched off on the unit
- Announcement transmission can be switched off on the unit
- Display of the time in idle state (can be switched off on the unit)
- Direct connection to the IP network of the nurse call system, RJ45 socket on the unit
- Power supply via PoE+ or via separate 24 V DC supply (2-pole screw connector)
- Reverse polarity protection, over-voltage protection
- Incl. ceiling suspension, 50 cm long, steplessly adjustable

Corridor display^{IP} Alpha 16, double-sided

76 0160 00

- Page 2 -

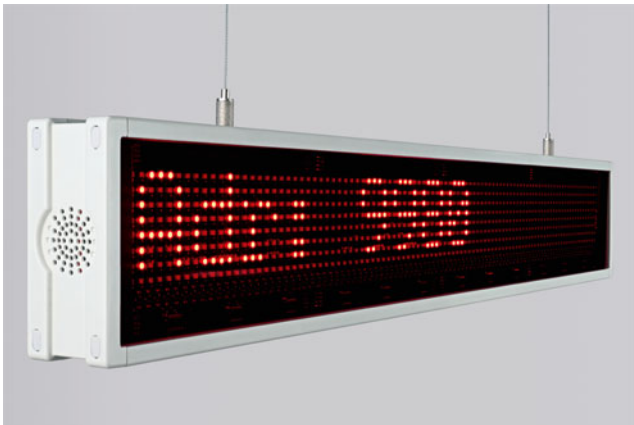

Technical data

Dimensions (HxWxD):	145 x 785 x 55 mm
Weight:	approx. 2500 g
Housing material:	Aluminium, lacquered, with end caps made of ABS, lacquered
Front window material:	Acrylic glass
Housing colour:	RAL 9003, signal white
Character height:	50 mm
Ingress protection code:	IP20
Current consumption:	
- in standby:	140 mA at 24 V DC
- on call:	450 mA at 24 V DC
Power consumption:	
- in standby:	4.3 W at PoE+
- on call:	13.0 W at PoE+
Ambient temperature:	+5 °C to +40 °C
Relative humidity:	0 % 85 %, (non-condensing)

Order no.	Product name	Note
76 0160 00	Corridor display ^{IP} Alpha 16, double-sided	double-sided version
Optional accessories, order if required:		
19 0780 05	Extension set for ceiling suspension, 0.5 m	for double-sided display

ComTerminal^{IP}, PoE

76 0510 00



General description

Universal communication terminal with VoIP technology. Designed for use in patient rooms, staff rooms, and function rooms.

Equipped as standard with all control elements required for communication between patients and staff.

The operating front made of real glass meets the highest demands in terms of cleaning, operation and design.

The ComTerminal^{IP}, PoE controls and monitors all room functions according to the German standard DIN VDE 0834. The integrated interfaces allow the connection to the IP network of the nurse call system (incl. PoE+) and the connection of the room bus (RAN).

All connections are made via an integrated connection panel. An RJ45 jack is used to connect the IP network. A supplied flexible patch cable serves as a connection to the RJ45 jack installed on site in the back box (e.g. keystone module, field-assembly).

The basic nurse call functions are still available in the room even in the event of system faults. This ensures a high degree of operational reliability.

The ComTerminal^{IP}, PoE offers maximum ease of operation thanks to operation via a full-colour 3.5" touch display and separate sensor buttons for presence registration, call triggering and alarm triggering.

System characteristics

- Room bus (RAN) for connection of further operating elements and signalling devices
- Identification for maximum 6 beds

Specification

- Operating front made of real glass with integrated touch display, sensor buttons and indicators for simple and intuitive operation
- Surface mounting, plug-in electronic components
- Integrated connection field
- Fully equipped for all applications
- Simple use due to logic and ergonomic control elements with international symbols
- Red call button with symbol, location light and reassurance light
- Blue cardiac alarm button (code blue) with symbol, location light and reassurance light, configurable
- Green large presence button for staff 1, with reminder light
- Yellow large presence button for staff 2, with reminder light
- High-quality 3.5" touch display, illuminated, for operation and display of calls and information messages
- Excellent voice quality through VoIP technology
- High-quality loudspeakers and sensitive microphone
- Integrated configuration menu for selecting room functions and setting system parameters

ComTerminal^{IP}, PoE

76 0510 00

- Page 2 -



Specification (continuation)

- Integrated function monitoring with status indication
- Language selectable by configuration
- Closed, smooth surface, easy to clean and disinfect
- Moisture-protected casing

Technical data

Dimensions (HxWxD):	205 x 110 x 34 mm
Power supply:	PoE+
Standby current consumption:	5.8 W
Colour:	white
Housing material:	ABS, operating front: real glass
Interfaces:	Room bus (RAN) IP network

Order no.	Product name	Note
76 0510 00	ComTerminal ^{IP} , PoE	
Necessary accessories, order separately:		
17 0410 00	Back box solid wall, 2-gang	see appendix "Accessories"
17 5400 00	Back box partition wall, 2-gang	see appendix "Accessories"

ComTerminal^{IP}, 24V

76 0510 10



General description

Universal communication terminal with VoIP technology. Designed for use in patient rooms, staff rooms, and function rooms.

Equipped as standard with all control elements required for communication between patients and staff.

The operating front made of real glass meets the highest demands in terms of cleaning, operation and design.

The ComTerminal^{IP}, 24V controls and monitors all room functions according to the German standard DIN VDE 0834. The integrated interfaces allow the connection to the IP network of the nurse call system, to the room bus (RAN) and to the 20 VDC power supply cable.

All connections are made via an integrated connection panel. An RJ45 jack is used to connect the IP network. A supplied flexible patch cable serves as a connection to the RJ45 jack installed on site in the back box (e.g. keystone module, field-assembly).

The basic nurse call functions are still available in the room even in the event of system faults. This ensures a high degree of operational reliability.

The ComTerminal^{IP}, 24V offers maximum ease of operation thanks to operation via a full-colour 3.5" touch display and separate sensor buttons for presence registration, call triggering and alarm triggering.

System characteristics

- Room bus (RAN) for connection of further operating elements and signalling devices
- Identification for maximum 6 beds

Specification

- Operating front made of real glass with integrated touch display, sensor buttons and indicators for simple and intuitive operation
- Surface mounting, plug-in electronic components
- Integrated connection field
- Fully equipped for all applications
- Simple use due to logic and ergonomic control elements with international symbols
- Red call button with symbol, location light and reassurance light
- Blue cardiac alarm button (code blue) with symbol, location light and reassurance light, configurable
- Green large presence button for staff 1, with reminder light
- Yellow large presence button for staff 2, with reminder light
- High-quality 3.5" touch display, illuminated, for operation and display of calls and information messages
- Excellent voice quality through VoIP technology
- High-quality loudspeakers and sensitive microphone
- Integrated configuration menu for selecting room functions and setting system parameters

ComTerminal^{IP}, 24V

76 0510 10

- Page 2 -



Specification (continuation)

- Integrated function monitoring with status indication
- Language selectable by configuration
- Closed, smooth surface, easy to clean and disinfect
- Moisture-protected casing

Technical data

Dimensions (HxWxD):	205 x 110 x 34 mm
Power supply:	24 V DC
Standby current consumption:	132 mA
Colour:	white
Housing material:	ABS, operating front: real glass
Interfaces:	Room bus (RAN) IP network

Order no.	Product name	Note
76 0510 10	ComTerminal ^{IP} , 24V	
Necessary accessories, order separately:		
17 0410 00	Back box solid wall, 2-gang	see appendix "Accessories"
17 5400 00	Back box partition wall, 2-gang	see appendix "Accessories"

ComStation^{IP}

76 0605 50



General description

The ComStation^{IP} is a ward console for the nurse station, designed for answering and handling calls.

The ComStation^{IP} is based on an IP desktop telephone with an adapted Android operating system. The nurse call function is pre-installed as an application on the IP telephone. It is operated via a large touch display with a 7-inch screen diagonal.

System messages and additional information can be displayed.

The HD Voice capable hardware and VoIP voice transmission ensure excellent voice quality and intelligibility in all operating modes.

The ComStation^{IP} supports the nursing organisation through the possibilities of ward coupling and operation according to predefined shifts. As it is an IP terminal it can be used locationally flexible.

Specification

- Ward console configured for standard ward operation
- Answering and handling of calls
- Selective announcements with up to four defined presence-related person groups
- Enabling and disabling of ward coupling
- Enabling and disabling of shifts
- Display of system messages
- Handset or hands-free speech
- Capacitive 5-point Wide SVGA touch display, 7", resolution: 1024x600 Pixel
- Desktop or wall mounting
- Connection via standard patch cable to the IP network of the nurse call system
- Power supply via PoE or included plug-in power supply unit
- App help

Technical data

Dimensions (HxWxD):	84 x 252 x 211 mm
Power consumption PoE:	approx. 11 W
Power consumption using plug-in power supply unit:	approx. 9 W
Weight:	1080 g
Colour:	Black
Housing material, handset:	ABS
Touch screen material:	Glass
Spiral cable:	Soft PVC
Ambient temperature:	
- Operation:	0 °C to +40 °C
- Storage:	-10 °C to +60 °C
Relative humidity:	10 % to 90 %, (non-condensing)

Order no.	Product name	Note
76 0605 50	ComStation ^{IP}	

System module HEALTH

76 0730 00



- Supporting different organisational concepts: centralised, decentralised, mixed
- Managing additionally installed function modules, e.g. telephony
- Controlling all connected interfaces and displays

Characteristics

- 2 staff presence groups
- At least 10 different call types
- Signalling according to DIN VDE 0834
- Bed identification
- Speech communication: Room, bed
- Automatically controlled privacy function
- Various announcements: Rooms, areas
- Zone nursing
- Ward couplings
- Automatic call transfer
- Call handling between wards

General description

System software for the operation of a nurse call system, intended for the use in hospitals or similar institutions. The system module is supplied pre-installed on an IP-SystemManager (to be purchased separately).

The system module HEALTH provides the function of a complete nurse call system and can be combined with further function modules.

Scope of functions

- Controlling one organisational group of a nurse call system
- Coordinates overacting performance features when several IP-SystemManagers are coupled
- Suitable for systems with or without speech communication
- Functional characteristics according to DIN VDE 0834
- Permanent system monitoring of all connected components

System maintenance

In order to keep the system and the installed system modules up-to-date, it is mandatory to conclude a software support contract. The annual costs include the usage rights and a regular software maintenance in the form of security updates to ensure system integrity.

Order no.	Product name	Note
76 0730 00	System module HEALTH	
Mandatory software support, purchase separately:		
76 7130 00	Software support System module HEALTH	see appendix "Services"

System module CARE

76 0735 00



- Supporting different organisational concepts: centralised, decentralised, mixed
- Managing additionally installed function modules, e.g. telephony
- Controlling all connected interfaces and displays

Characteristics

- 2 staff presence groups
- At least 10 different call types
- Signalling according to DIN VDE 0834
- Bed identification
- Speech communication: Room, bed
- Automatically controlled privacy function
- Various announcements: Rooms, areas
- Zone nursing
- Ward couplings
- Automatic call transfer
- Call handling between wards

General description

System software for the operation of a nurse call system, intended for the use in nursing homes or similar institutions. The system module is supplied pre-installed on an IP-SystemManager (to be purchased separately).

The system module CARE provides the function of a complete nurse call system and can be combined with further function modules.

Scope of functions

- Controlling one organisational group of a nurse call system
- Coordinates overacting performance features when several IP-SystemManagers are coupled
- Suitable for systems with or without speech communication
- Functional characteristics according to DIN VDE 0834
- Permanent system monitoring of all connected components

System maintenance

In order to keep the system and the installed system modules up-to-date, it is mandatory to conclude a software support contract. The annual costs include the usage rights and a regular software maintenance in the form of security updates to ensure system integrity.

Order no.	Product name	Note
76 0735 00	System module CARE	
Mandatory software support, purchase separately:		
76 7135 00	Software support System module CARE	see appendix "Services"

Function module UM/A

76 0740 00

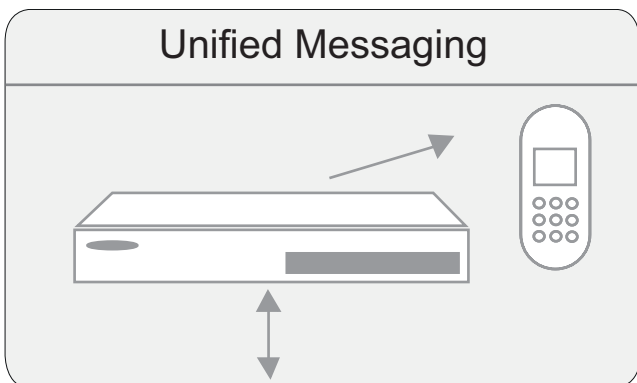

General description

The function module UM/A effectively complements a Flamenco^{IP+} or Flamenco^{IP} nurse call system. It serves for an unidirectional connection of telephone systems or pagers to nurse call system.

The function module is supplied pre-installed on an IP-SystemManager (to be purchased separately). It makes the functionality available in the entire nurse call system.

Messages from the nurse call system are selectively forwarded to mobile devices, e.g. DECT, and are displayed there.

Interface

The telephony system and/or the messaging server is physically connected to the LAN.

Function module UM/A supports Ascom systems.

Specification

The standard range of functions is described in the appropriate product description.

- Displaying of messages from the nurse call system: Calls, emergency calls, alarms
- Displaying of calling location: Bed, room, ward
- Acknowledgement of the message
- Confirmation of call acceptance

System maintenance

In order to keep the system and the installed function modules up-to-date, it is mandatory to conclude a software support contract. The annual costs include the usage rights and a regular software maintenance in the form of security updates to ensure system integrity.

Order no.	Product name	Note
76 0740 00	Function module UM/A	
Mandatory software support, purchase separately:		
76 7040 00	Software support Function module UM/UMS	see appendix "Services"

Function module UMS/A

76 0740 01

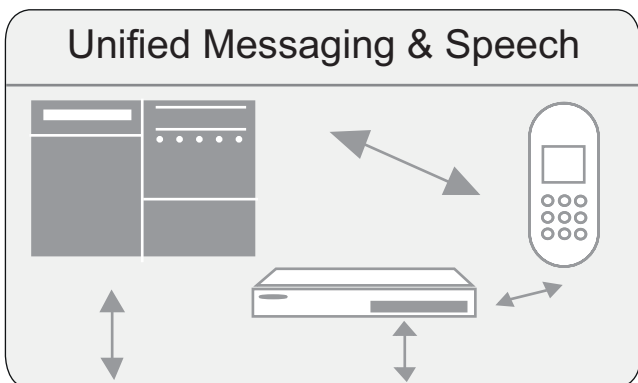

General description

The function module UMS/A effectively complements a Flamenco^{IP+} or Flamenco^{IP} nurse call system. It serves for an unidirectional connection of telephone systems or pagers to the nurse call system. This extended connection supports speech communication, SIP/VoIP.

The function module is supplied pre-installed on an IP-SystemManager (to be purchased separately). It makes the functionality available in the entire nurse call system.

Messages from the nurse call system are selectively forwarded to mobile devices, e.g. DECT, and are displayed there. Speech communication can take place between the nurse call system and the telephony system.

Interface

The telephony system and/or the messaging server is physically connected to the LAN.

Function module UMS/A supports Ascom systems

Specification

The standard range of functions is described in the appropriate product description.

- Displaying of messages from the nurse call system: Calls, emergency calls, alarms
- Displaying of calling location: Bed, room, ward
- Acknowledgement of the message
- Confirmation of call acceptance
- Cancelling of calls (if permitted)

System maintenance

In order to keep the system and the installed function modules up-to-date, it is mandatory to conclude a software support contract. The annual costs include the usage rights and a regular software maintenance in the form of security updates to ensure system integrity.

Order no.	Product name	Note
76 0740 01	Function module UMS/A	
Mandatory software support, purchase separately:		
76 7040 00	Software support Function module UM/UMS	see appendix "Services"

Function module UMS/T

76 0740 10

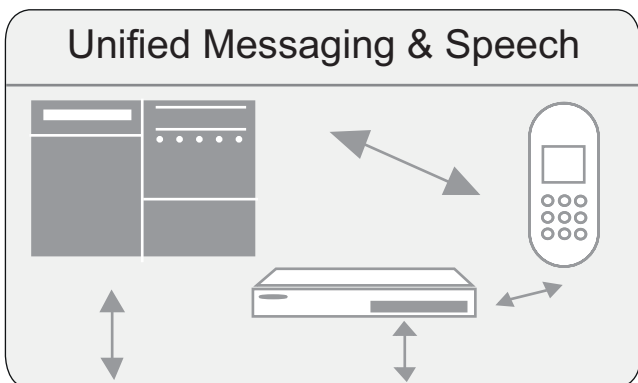

General description

The function module UMS/T effectively complements a Flamenco^{IP+} or Flamenco^{IP} nurse call system. It serves for an unidirectional connection of telephone systems or pagers to the nurse call system. This extended connection supports speech communication, SIP/VoIP.

The function module is supplied pre-installed on an IP-SystemManager (to be purchased separately). It makes the functionality available in the entire nurse call system.

Messages from the nurse call system are selectively forwarded to mobile devices, e.g. DECT, and are displayed there. Speech communication can take place between the nurse call system and the telephony system.

Interface

The telephony system and/or the messaging server is physically connected to the LAN.

Function module UMS/T supports Tetronik systems.

Specification

The standard range of functions is described in the appropriate product description.

- Displaying of messages from the nurse call system: Calls, emergency calls, alarms
- Displaying of calling location: Bed, room, ward
- Acknowledgement of the message
- Confirmation of call acceptance
- Cancelling of calls (if permitted)

System maintenance

In order to keep the system and the installed function modules up-to-date, it is mandatory to conclude a software support contract. The annual costs include the usage rights and a regular software maintenance in the form of security updates to ensure system integrity.

Order no.	Product name	Note
76 0740 10	Function module UMS/T	
Mandatory software support, purchase separately:		
76 7040 00	Software support Function module UM/UMS	see appendix "Services"

Function module MED

76 0741 00

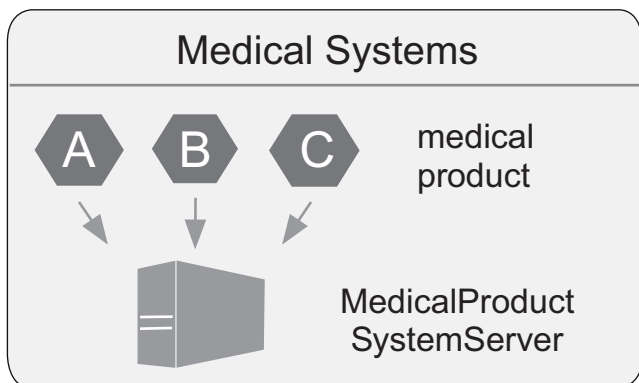

General description

The function module MED effectively complements a Flamenco^{IP+} or Flamenco^{IP} nurse call system. It serves for an unidirectional connection of electro-medical systems to the nurse call system.

The function module is supplied pre-installed on an IP-SystemManager (to be purchased separately to be purchased separately). It makes the functionality available for the entire nurse call system.

Filtered messages are received by the nurse call system and displayed there. Hereby the priorities, the display order, and the display location can be configured.

The displayed data can be received from the interface or can be assigned in a separate table.

Interface

The communication is realised using ESPA 4.4.4 protocol via a serial interface RS 232.

The choice of the data to be transferred and the configuration is made in a close agreement with the customer.

Specification

The standard range of functions is described in the appropriate product description.

Important note

When coupling electro-medical systems with the nurse call system, the purpose must be taken into account.

System maintenance

In order to keep the system and the installed function modules up-to-date, it is mandatory to conclude a software support contract. The annual costs include the usage rights and a regular software maintenance in the form of security updates to ensure system integrity.

Order no.	Product name	Note
76 0741 00	Function module MED	
Mandatory software support, purchase separately:		
76 7041 00	Software support Function module MED/FAS	see appendix "Services"

Function module FAS

76 0742 00

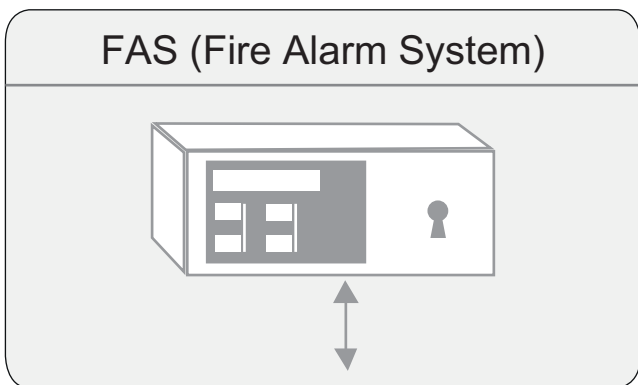

General description

The function module FAS effectively complements a Flamenco^{IP+} or Flamenco^{IP} nurse call system. It serves for an unidirectional connection of fire alarm systems to the nurse call system.

The function module is supplied pre-installed on an IP-SystemManager (to be purchased separately). It makes the functionality available for the entire nurse call system.

Filtered messages are received by the nurse call system and displayed there. Hereby the priorities, the display order, and the display location can be configured.

The displayed data can be received from the interface or can be assigned in a separate table.

Interface

The communication is realised using ESPA 4.4.4 protocol via a serial interface RS232.

The choice of the data to be transferred and the configuration is made in a close agreement with the customer.

Specification

The standard range of functions is described in the appropriate product description.

System maintenance

In order to keep the system and the installed function modules up-to-date, it is mandatory to conclude a software support contract. The annual costs include the usage rights and a regular software maintenance in the form of security updates to ensure system integrity.

Order no.	Product name	Note
76 0742 00	Function module FAS	
Mandatory software support, purchase separately:		
76 7041 00	Software support Function module MED/FAS	see appendix "Services"

Function module VOIP GATE

76 0743 00

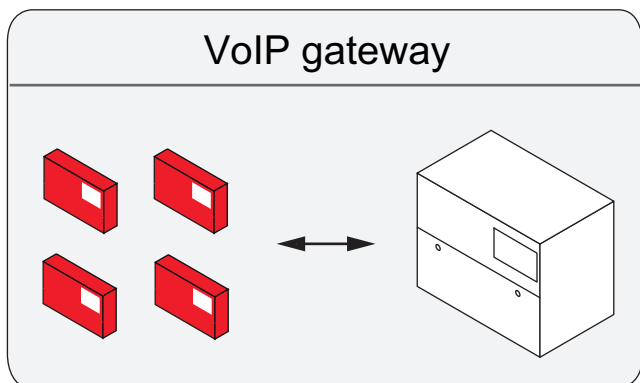

General description

The function module VOIP GATE effectively complements a Flamenco^{IP+} or Flamenco^{IP} nurse call system.

The function module is supplied pre-installed on an IP-SystemManager (to be purchased separately). It represents a gateway to VoIP applications.

With this gateway, the speech coupling of a ManagementCenter to the Flamenco^{IP+} or Flamenco^{IP} nurse call system is possible. An IP-SystemManager with the VOIP GATE function module enables the connection of one ManagementCenter, i.e. one console workstation.

With this gateway, the speech coupling of an OSY-ControlCenter (Flamenco system) to the Flamenco^{IP+} or Flamenco^{IP} nurse call system is possible. An IP-SystemManager with VOIP GATE function module enables the connection of two speech lines of the OSY-ControlCenter.

Interface

The communication is established via the NF connection terminal of the IP-SystemManagers. Depending on the number of requested speech channels possibly several IP-SystemManager have to be installed for the application.

System maintenance

In order to keep the system and the installed function modules up-to-date, it is mandatory to conclude a software support contract. The annual costs include the usage rights and a regular software maintenance in the form of security updates to ensure system integrity.

Order no.	Product name	Note
76 0743 00	Function module VOIP GATE	
Mandatory software support, purchase separately:		
76 7042 00	Software support Function module VOIP GATE	see appendix "Services"

IP-SystemManager

76 2100 00



General description

Decentralised control unit for Flamenco^{IP+} or Flamenco^{IP} nurse call systems. One IP-SystemManager is suitable to control one organisational group, i.e. usually one ward. An organisational group may have a maximum of 55 rooms.

The number of required IP-SystemManagers for one complete system depends on the number of wards and required central interfaces. The project-specific system design and determination of the necessary components take place during project planning.

All IP-SystemManagers are equipped with the same hardware. Their functional differences result from the installed software (system module, function module) and a project-specific configuration. The IP-SystemManagers are set up according to the requirements and configured with the provided project-specific data at the factory, as far as they are known.

Several IP-SystemManagers are networked via an IP network (LAN). One IP-SystemManager in the system manages and coordinates cross-ward functions such as ward coupling, speech communication and superordinate system messages.

System and function modules

Various system and function modules are available for installation on the IP-SystemManagers - from the basic nurse call function up to complex interfaces. Single modules can be added and the system can be expanded at any time.

The modules are not part of the IP-SystemManager product. They must be purchased separately.

For safety reasons, an additional IP-SystemManager is needed for connecting medical systems or fire alarm systems to the nurse call system. The local legal and normative requirements and regulations must be observed for the connection.

System design

An IP-SystemManager can work in standalone operation; i.e., it provides complete control for a nurse call system that may consist of only one organisational unit.

For the setup of larger systems, up to 64 IP-SystemManagers can be networked. Interconnection can be implemented through IP networks dedicated solely for the nurse call system or through the existing on-site IP network infrastructures. Here, the requirements of the corresponding standards, e.g., DIN VDE 0834, must be taken into consideration.

Through the separation of the physical system structure and the later organisation of the nurse call system, the formation of wards and organisational groups is very easy and not bound to a fixed grid. This is independent of the number of IP-SystemManagers and their arrangement in the system.

Through the use of digital voice processes and VoIP technology, the IP-SystemManager provides excellent voice quality throughout the entire system.

The respective system status can be recognised locally and system-wide using corresponding displays at any time.

With an IP SystemManager, both IP-based devices and devices on the OSYnet group bus can be operated, i.e. mixed operation is possible.

IP-SystemManager

76 2100 00

- Page 2 -

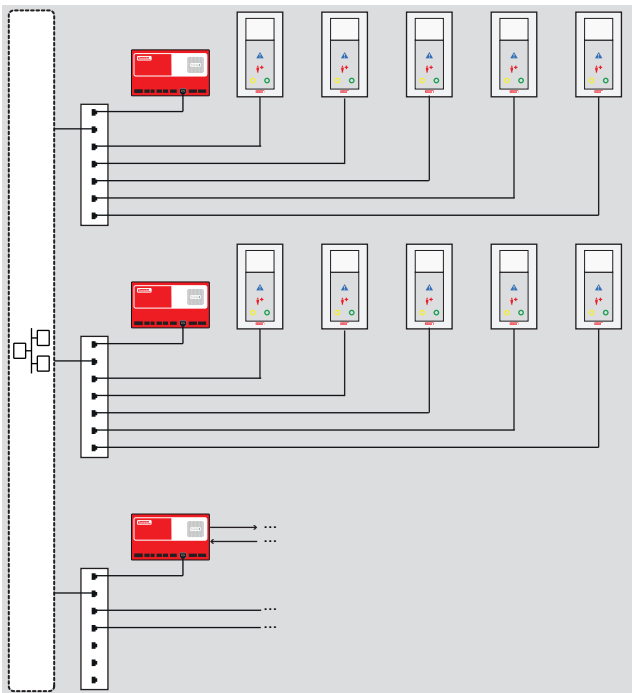

ensure system integrity.

Setup and equipment

- Device for mounting to a top-hat rail with 2 top-hat rail retaining clips on the rear of the device
- Possible installation into a 19" cabinet with optionally available accessories, spatial requirement: 3 U
- Pluggable screw connectors for easy assembly and troubleshooting
- Status LED (green) flashes when the IP-System-Manager is in operation
- Remote access or system updates possible through the IP network
- Easy to access service cover
- Subsequent system expansion or system changes possible without a problem
- The OSYnet group bus of an existing Flamenco installation can be easily converted to control by an IP-SystemManager

Functional safety

Permanent monitoring of the functionality of all connected components, including the interfaces and network connections, insofar as made possible by the connected systems and components.

In case an IP-SystemManager fails, the other IP-SystemManagers of the nurse call system continue to work.

The ward with the failed IP-SystemManager switches to minimum operation, i.e., the signalling of calls using the room lamps and call cancellation at the call location.

In case of the failure of systems or devices connected by interfaces and/or networks, the basic function of the nurse call system is always retained.

System maintenance

In order to keep the system and the installed system and function modules up-to-date, it is mandatory to conclude a software support contract. The annual costs include the usage rights and a regular software maintenance in the form of security updates to

Power supply

The IP-SystemManager is supplied with 24 V DC through the nurse call system. Depending on the system setup, a separate power supply can also be used.

- Power supply, 24 V DC, 4-pole, with LED indicator (green) in case of existing power supply
- Input for buffering message of the UPS control unit 10A (order no. 77 3411 00) or the battery message of the power supply unit UPS (order no. 77 3400 00), 2-pole, with LED indicator (red) in case of battery message

Fault messages

All fault messages of the nurse call system are displayed on one IP-SystemManager. This IP-SystemManager is determined during the planning of the system.

- LED indicator (red) for fault message
- Fault signal output, changeover contact, potential free, 2-pole, parallel function to LED indicator

IP-SystemManager

76 2100 00

- Page 3 -

Connection of OSYnet 1 group bus

It is technically possible, to connect a maximum of 110 bus users to one OSYnet group bus. The IP-SystemManager must be installed at the beginning or end of the group bus.

- OSYnet 1, 3-pole: Data wires of the OSYnet group bus; with LED indicators for Rx (green) and Tx (yellow)
- NF 1, 2-pole: Speech wires of the OSYnet group bus, with LED indicator (yellow)

Connection of OSYnet 2 group bus

Not used.

Ethernet connection

The IP-SystemManager communicates via the IP network with all ComTerminals^{IP} and other IP-based components of the organisational group, with the other IP-SystemManagers of the nurse call system and with external devices or systems that are connected to the nurse call system via the IP network (e.g. PBX).

- Ethernet, 10/100 Mbit LAN connection RJ45, max. cable length: 90 m
- LED indicator (green) for Link and LED indicator (yellow) for Speed
- The Ethernet connection is internally equipped with a separation point according to DIN EN 60601-1 (2xMOPP). An external separation point is therefore not required.

ESPA 4.4.4 interfaces

The IP-SystemManager is equipped with two RS232 connections using the ESPA 4.4.4 protocol. These connections are suitable for the connection of radio paging systems, DECT systems, fire alarm systems and medical systems. The release and use of these connections requires the purchasing of the corresponding function modules.

- RS232 A, 5-pole, ESPA 4.4.4, with LED indicator (green) for Rx and LED indicator (yellow) for Tx; max. cable length: 10 m
- RS232 B, 5-pole, ESPA 4.4.4, with LED indicator (green) for Rx and LED indicator (yellow) for Tx; max. cable length: 10 m
- When using an RS232 connection, an external separating device according to DIN EN 60601-1 (2xMOPP) must be inserted.

Technical data

Dimensions (HxWxD):	132 x 216 x 48 mm
Power supply:	24 V DC
Permissible voltage range:	20 – 26 V DC
Standby current consumption:	120 mA
Housing colour:	Red
Housing material:	PS UL94-HB
Colour of the service cover:	White
Material of the service cover:	ABS
Weight:	415 g
Ingress protection code:	IP20
Ambient temperature:	+5 °C to +40 °C
Relative humidity:	0 % to 85 % (non-condensing)

IP-SystemManager

76 2100 00

- Page 4 -



Order no.	Product name	Note
76 2100 00	IP-SystemManager	
Software (system and function modules)* to be purchased separately:		
76 0730 00	System module HEALTH	One IP-SystemManager is required per organisational group, on which a HEALTH or CARE system module is installed, see appropriate data sheets.
76 0735 00	System module CARE	
76 0740 00	Function module UM/A	For messaging to Ascom systems, an IP-SystemManager is required on which a function module UM/A is installed in addition to a system module, see appropriate data sheet.
76 0740 01	Function module UMS/A	For messaging and speech connection to Ascom systems, an IP-SystemManager is required on which a function module UMS/A is installed in addition to a system module, see appropriate data sheet.
76 0740 10	Function module UMS/T	For messaging and speech connection to Tetronik systems, an IP-SystemManager is required on which a function module UMS/T is installed in addition to a system module, see appropriate data sheet.
76 0741 00	Function module MED	For each connection of a medical electrical system, an IP-SystemManager is required on which the MED function module is installed, see appropriate data sheet.
76 0742 00	Function module FAS	For each connection of a fire alarm system, an IP-SystemManager is required on which the FAS function module is installed, see appropriate data sheet.
76 0743 00	Function module VOIP GATE	An IP-SystemManager with the VOIP GATE function module enables the connection of one ManagementCenter, i.e. one console workstation, see appropriate data sheet.
*) For each system or function module the software support must be purchased separately.		
Optional accessories, order if required:		
76 0900 01	19" Mounting set	see appendix "Accessories"

Ethernet switch, 8 port

10/100 Mbit/s, unmanaged

76 4500 00



(Image similar)

General description

The switch is suitable for use in Flamenco nurse call systems and can be directly mounted on a standard top-hat rail.

Specification

- Unmanaged switch, IEEE 802.3
- 10/100 Mbit Ethernet
- 8 ports (RJ45)
- Autonegotiation and autocrossing
- LED status displays
- Potential-free signalling contact signals power supply failure (24 V DC), current carrying capacity: typically 100 mA.
- Mounting on a standard top-hat rail
- Pluggable screw connection to the power supply (maximum 2.5 mm²)

Technical data

Dimensions (HxWxD):	94 x 135 x 30 mm
Weight:	282 g
Power supply:	24 V DC
Supply voltage range:	18.5 V DC – 30,2 V DC
Current consumption:	typ. 95 mA (at 24 V DC) max. 240 mA
Housing material:	Aluminium
Ingress protection code:	IP20
Ambient temperature	
- Storage/Transport:	-20 °C to 70 °C
- Operation:	0 °C to 55 °C
Relative humidity:	5 % to 95 % (non-condensing)

Order no.	Product name	Note
76 4500 00	Ethernet switch, 8 port	

Room lamp, 3 sections

77 0170 00



Specification

- 3 light sections
- Energy-saving, long-life LED illuminants
- Pluggable LED modules for easy change
- German utility patent
- German design patent
- Easy plug and play installation
- Integrated electronic processor for 3-pole plug-in connection to the room bus (RAN)
- Standard set to channel 0

Optical signalling

- LED red: Calls
- LED green: Staff group 1
- LED yellow: Staff group 2

General description

Signal lamp with 3 light sections for optical signalling of all call types and staff presences (2 staff groups).

Suitable for wall mounting in corridors or rooms. Modular design with replaceable decorative frame.

Further designs available on request.

Compatible with Flamenco system family and EccoLine with speech system.

Technical data

Dimensions (HxWxD):	110 x 150 x 40 mm
Colour:	Silver
Housing material:	ABS
Light dome material:	Styrene-acrylonitrile
Power supply	24 V DC
Current consumption:	30 mA per light section

Order number	Product name	Notes
77 0170 00	Room lamp, 3 sections	as described above
Necessary accessories, order separately:		
17 0100 00	Back box solid wall, 1-gang	see appendix "Accessories"
17 5100 00	Back box partition wall, 1-gang	see appendix "Accessories"
70 0807 00	Connector, 3-pole	see appendix "Accessories"

Room lamp cardiac alarm, WC

77 0170 01



General description

Signal lamp with 3 light sections as complement to room lamp, order no. 77 0170 00, for optical signalling of cardiac alarms and/or WC calls.

Suitable for wall mounting in corridors or rooms. Modular design with replaceable decorative frame.

Further designs available on request.

The signal lamp is installed either in the corridor besides the room lamp (e.g. order no. 77 0170 00) for explicit signalling of WC calls and/or cardiac alarm or it is installed besides the WC door in the patient room

for displaying the direction to the WC call.

Compatible with Flamenco system family and EccoLine with speech system.

Specification

- 3 light sections
- Energy-saving, long-life LED illuminants
- Pluggable LED modules for easy change
- German utility patent
- German design patent
- Easy plug and play installation
- Integrated electronic processor for 3-pole plug-in connection to the room bus (RAN)
- Standard set to channel 0

Optical signalling

- LED blue: Cardiac alarm
- LED blue: Cardiac alarm
- LED white: WC call

Technical data

Dimensions (HxWxD):	110 x 150 x 40 mm
Colour:	Silver
Housing material:	ABS
Light dome material:	Styrene-acrylonitrile
Power supply	24 V DC
Current consumption:	30 mA per light section

Order number	Product name	Notes
77 0170 01	Room lamp cardiac alarm, WC	as described above
Necessary accessories, order separately:		
17 0100 00	Back box solid wall, 1-gang	see appendix "Accessories"
17 5100 00	Back box partition wall, 1-gang	see appendix "Accessories"
70 0807 00	Connector, 3-pole	see appendix "Accessories"

Room lamp, 4 sections

77 0170 10



Specification

- 4 light sections
- Energy-saving, long-life LED illuminants
- Pluggable LED modules for easy change
- German utility patent
- German design patent
- Easy plug and play installation
- Integrated electronic processor for 3-pole plug-in connection to the room bus (RAN)
- Standard set to channel 0

Optical signalling

- LED red: Calls
- LED green: Staff group 1
- LED yellow: Staff group 2
- LED white: WC call

General description

Signal lamp with 4 light sections for optical signalling of all call types, staff presences (2 staff groups), and for WC call as single display.

Suitable for wall mounting in corridors or rooms. Modular design with replaceable decorative frame.

Further designs available on request.

Compatible with Flamenco system family and EccoLine with speech system.

Technical data

Dimensions (HxWxD):	110 x 150 x 40 mm
Colour:	Silver
Housing material:	ABS
Light dome material:	Styrene-acrylonitrile
Power supply	24 V DC
Current consumption:	30 mA per light section

Order number	Product name	Notes
77 0170 10	Room lamp, 4 sections	as described above
Necessary accessories, order separately:		
17 0100 00	Back box solid wall, 1-gang	see appendix "Accessories"
17 5100 00	Back box partition wall, 1-gang	see appendix "Accessories"
70 0807 00	Connector, 3-pole	see appendix "Accessories"

Room lamp, 3 sections, with doorplate

77 0171 00



Specification

- 3 light sections
- Energy-saving, long-life LED illuminants
- Pluggable LED modules for easy change
- German utility patent
- German design patent
- Easy plug and play installation
- Integrated electronic processor for 3-pole plug-in connection to the room bus (RAN)
- Standard set to channel 0

Optical signalling

- LED red: Calls
- LED green: Staff group 1
- LED yellow: Staff group 2

General description

Signal lamp with 3 light sections for optical signalling of all call types and staff presences (2 staff groups). Doorplate as label field for room designation.

Suitable for wall mounting in corridors or rooms. Modular design.

Compatible with Flamenco system family and EccoLine with speech system.

Technical data

Dimensions (HxWxD):	190 x 150 x 40 mm
Label field (HxW):	approx. 70 x 92 mm
Colour:	Silver
Housing material:	ABS
Light dome material:	Styrene-acrylonitrile
Power supply	24 V DC
Current consumption:	30 mA per light section

Order number	Product name	Notes
77 0171 00	Room lamp, 3 sections, with doorplate	as described above
Necessary accessories, order separately:		
17 0100 00	Back box solid wall, 1-gang	see appendix "Accessories"
17 5100 00	Back box partition wall, 1-gang	see appendix "Accessories"
70 0807 00	Connector, 3-pole	see appendix "Accessories"

Room lamp, 4 sections, with doorplate

77 0171 10



Specification

- 4 light sections
- Energy-saving, long-life LED illuminants
- Pluggable LED modules for easy change
- German utility patent
- German design patent
- Easy plug and play installation
- Integrated electronic processor for 3-pole plug-in connection to the room bus (RAN)
- Standard set to channel 0

Optical signalling

- LED red: Calls
- LED green: Staff group 1
- LED yellow: Staff group 2
- LED white: WC call

General description

Signal lamp with 4 light sections for optical signalling of all call types, staff presences (2 staff groups), and for WC call as single display. Doorplate as label field for room designation.

Suitable for wall mounting in corridors or rooms. Modular design with replaceable decorative frame.

Further designs available on request.

Compatible with Flamenco system family and EccoLine with speech system.

Technical data

Dimensions (HxWxD):	190 x 150 x 40 mm
Label field (HxW):	approx. 70 x 92 mm
Colour:	Silver
Housing material:	ABS
Light dome material:	Styrene-acrylonitrile
Power supply	24 V DC
Current consumption:	30 mA per light section

Order number	Product name	Notes
77 0171 10	Room lamp, 4 sections, with doorplate	as described above
Necessary accessories, order separately:		
17 0100 00	Back box solid wall, 1-gang	see appendix "Accessories"
17 5100 00	Back box partition wall, 1-gang	see appendix "Accessories"
70 0807 00	Connector, 3-pole	see appendix "Accessories"

Room lamp, 3 sections

glass decor

77 0175 00



General description

Signal lamp with 3 light sections for optical signalling of all call types and staff presences (2 staff groups).

Suitable for wall mounting in corridors or rooms. Modular design with replaceable decorative glass frame.

Compatible with Flamenco system family and EccoLine with speech system.

Specification

- 3 light sections
- Energy-saving, long-life LED illuminants
- Pluggable LED modules for easy change
- German utility patent
- German design patent
- Easy plug and play installation
- Integrated electronic processor for 3-pole plug-in connection to the room bus (RAN)
- Standard set to channel 0

Optical signalling

- LED red: Calls
- LED green: Staff group 1
- LED yellow: Staff group 2

Technical data

Dimensions (HxWxD):	110 x 150 x 40 mm
Design frame material:	Glass
Housing material:	ABS
Light dome material:	Styrene-acrylonitrile
Power supply	24 V DC
Current consumption:	30 mA per light section

Order number	Product name	Notes
77 0175 00	Room lamp, 3 sections	as described above
Necessary accessories, order separately:		
17 0100 00	Back box solid wall, 1-gang	see appendix "Accessories"
17 5100 00	Back box partition wall, 1-gang	see appendix "Accessories"
70 0807 00	Connector, 3-pole	see appendix "Accessories"

Room lamp cardiac alarm, WC

glass decor

77 0175 01



General description

Signal lamp with 3 light sections as complement to room lamp, order no. 77 0175 00, for optical signalling of cardiac alarms and/or WC calls.

Suitable for wall mounting in corridors or rooms. Modular design with replaceable decorative glass frame.

The signal lamp is installed either in the corridor besides the room lamp (e.g. order no. 77 0175 00) for explicit signalling of WC calls and/or cardiac alarm or it is installed besides the WC door in the patient room for displaying the direction to the WC call.

Compatible with Flamenco system family and EccoLine with speech system.

Specification

- 3 light sections
- Energy-saving, long-life LED illuminants
- Pluggable LED modules for easy change
- German utility patent
- German design patent
- Easy plug and play installation
- Integrated electronic processor for 3-pole plug-in connection to the room bus (RAN)
- Standard set to channel 0

Optical signalling

- LED blue: Cardiac alarm
- LED blue: Cardiac alarm
- LED white: WC call

Technical data

Dimensions (HxWxD):	110 x 150 x 40 mm
Design frame material:	Glass
Housing material:	ABS
Light dome material:	Styrene-acrylonitrile
Power supply	24 V DC
Current consumption:	30 mA per light section

Order number	Product name	Notes
77 0175 01	Room lamp cardiac alarm, WC	as described above
Necessary accessories, order separately:		
17 0100 00	Back box solid wall, 1-gang	see appendix "Accessories"
17 5100 00	Back box partition wall, 1-gang	see appendix "Accessories"
70 0807 00	Connector, 3-pole	see appendix "Accessories"

Room lamp, 4 sections

glass decor

77 0175 10



General description

Signal lamp with 4 light sections for optical signalling of all call types, staff presences (2 staff groups), and for WC call as single display.

Suitable for wall mounting in corridors or rooms. Modular design with replaceable decorative glass frame.

Compatible with Flamenco system family and EccoLine with speech system.

Specification

- 4 light sections
- Energy-saving, long-life LED illuminants
- Pluggable LED modules for easy change
- German utility patent
- German design patent
- Easy plug and play installation
- Integrated electronic processor for 3-pole plug-in connection to the room bus (RAN)
- Standard set to channel 0

Optical signalling

- LED red: Calls
- LED green: Staff group 1
- LED yellow: Staff group 2
- LED white: WC call

Technical data

Dimensions (HxWxD):	110 x 150 x 40 mm
Design frame material:	Glass
Housing material:	ABS
Light dome material:	Styrene-acrylonitrile
Power supply	24 V DC
Current consumption:	30 mA per light section

Order number	Product name	Notes
77 0175 10	Room lamp, 4 sections	as described above
Necessary accessories, order separately:		
17 0100 00	Back box solid wall, 1-gang	see appendix "Accessories"
17 5100 00	Back box partition wall, 1-gang	see appendix "Accessories"
70 0807 00	Connector, 3-pole	see appendix "Accessories"

Room lamp, 4 sections, C/A/PR/WC

silver design frame

77 0176 00



Specification

- 4 light sections
- Energy-saving, long-life LED illuminants
- Pluggable LED modules for easy change
- German utility patent
- German design patent
- Easy plug and play installation
- Integrated electronic processor for 3-pole plug-in connection to the room bus (RAN)
- Standard set to channel 0

Optical signalling

- LED red: All call types (except of cardiac alarms)
- LED blue: Cardiac alarm (Code blue)
- LED green: Presence of staff group 1
- LED white: WC call / WC emergency call

Technical data

Dimensions (HxWxD):	110 x 150 x 40 mm
Design frame colour:	Silver
Housing material:	ABS
Light dome material:	Styrene-acrylonitrile
Power supply	24 V DC
Current consumption:	30 mA per light section

NOTE! This room lamp is not permitted for the German market due to DIN VDE 0834-1:2016-6.

General description

Signal lamp with 4 light sections for optical signalling of calls, of staff presence, of alarms as a separate display, of calls in the WC as an additional display to the call display.

Suitable for wall mounting in corridors or rooms. Modular design with replaceable decorative frame.

Further designs available on request.

Compatible with Flamenco system family and EccoLine with speech system.

Order number	Product name	Notes
77 0176 00	Room lamp, 4 sections, C/A/PR/WC	as described above
Necessary accessories, order separately:		
17 0100 00	Back box solid wall, 1-gang	see appendix "Accessories"
17 5100 00	Back box partition wall, 1-gang	see appendix "Accessories"
70 0807 00	Connector, 3-pole	see appendix "Accessories"

Room lamp, 4 sections, C/A/PR/WC

white design frame

77 0176 01



Specification

- 4 light sections
- Energy-saving, long-life LED illuminants
- Pluggable LED modules for easy change
- German utility patent
- German design patent
- Easy plug and play installation
- Integrated electronic processor for 3-pole plug-in connection to the room bus (RAN)
- Standard set to channel 0

Optical signalling

- LED red: All call types (except of cardiac alarms)
- LED blue: Cardiac alarm (Code blue)
- LED green: Presence of staff group 1
- LED white: WC call / WC emergency call

General description

Signal lamp with 4 light sections for optical signalling of calls, of staff presence, of alarms as a separate display, of calls in the WC as an additional display to the call display.

Suitable for wall mounting in corridors or rooms. Modular design with replaceable decorative frame.

Further designs available on request.

Compatible with Flamenco system family and EccoLine with speech system.

Technical data

Dimensions (HxWxD):	110 x 150 x 40 mm
Design frame colour:	Traffic white, similar to RAL 9016
Housing material:	ABS
Light dome material:	Styrene-acrylonitrile
Power supply	24 V DC
Current consumption:	30 mA per light section

NOTE! This room lamp is not permitted for the German market due to DIN VDE 0834-1:2016-6.

Order number	Product name	Notes
77 0176 01	Room lamp, 4 sections, C/A/PR/WC	as described above
Necessary accessories, order separately:		
17 0100 00	Back box solid wall, 1-gang	see appendix "Accessories"
17 5100 00	Back box partition wall, 1-gang	see appendix "Accessories"
70 0807 00	Connector, 3-pole	see appendix "Accessories"

Call switch

77 0211 00...



77 0211 00 A



77 0211 00 C



77 0211 00 F

General description

Water protected switch with two call buttons with reassurance light for raising calls. The reassurance lights are on with a bright light, when a call was raised. While staff presence is switched on in the

room, an emergency call is raised.

The special design indicates the switch also optically as part of the nurse call system.

Preferably designed for wall mounting.

Specification

- 2 red call buttons with reassurance light and integrated night location light, red LED
- Easy plug and play installation
- Understandable labelling through clear symbol
- Large touch pads for easy operation
- Standard set to channel 0
- Integrated electronic processor for 3-pole plug-in connection to the room bus (RAN)
- Switch module with locking hooks for fixing on the support ring
- Support ring for screw fixing on a 1-gang back box
- Attractive design frame

Technical data

Power supply:	24 V DC
Standby current:	9 mA
Colour:	Studio white, similar to RAL 9016
Housing material:	Polycarbonate

Order number	Product name	Notes
77 0211 00 A	Call switch	Dimensions (HxWxD): 91 x 91 x 36 mm
77 0211 00 C	Call switch	Design frame made of white glass Dimensions (HxWxD): 107 x 107 x 36 mm
77 0211 00 F	Call switch	Dimensions (HxWxD): 80 x 80 x 36 mm
Necessary accessories, order separately:		
17 0100 00	Back box solid wall, 1-gang	see appendix "Accessories"
17 5100 00	Back box partition wall, 1-gang	see appendix "Accessories"
70 0807 00	Connector, 3-pole	see appendix "Accessories"

Call switch/WC

77 0211 01...



77 0211 01 A



77 0211 01 C



77 0211 01 F

The special design indicates the switch also optically as part of the nurse call system.

Preferably designed for wall mounting.

Specification

- 2 red call buttons with reassurance light and integrated night location light, red LED
- Easy plug and play installation
- Understandable labelling through clear symbol
- Large touch pads for easy operation
- Standard set to channel 0
- Integrated electronic processor for 3-pole plug-in connection to the room bus (RAN)
- Switch module with locking hooks for fixing on the support ring
- Support ring for screw fixing on a 1-gang back box
- Attractive design frame

Technical data

Power supply:	24 V DC
Standby current:	9 mA
Colour:	Studio white, similar to RAL 9016
Housing material:	Polycarbonate

General description

Water protected switch with two call buttons with reassurance light for raising WC calls. The reassurance lights are on with a bright light, when a call was raised. While staff presence is switched on in the room, a WC emergency call is raised.

Order number	Product name	Notes
77 0211 01 A	Call switch/WC	Dimensions (HxWxD): 91 x 91 x 36 mm
77 0211 01 C	Call switch/WC	Design frame made of white glass Dimensions (HxWxD): 107 x 107 x 36 mm
77 0211 01 F	Call switch/WC	Dimensions (HxWxD): 80 x 80 x 36 mm
Necessary accessories, order separately:		
17 0100 00	Back box solid wall, 1-gang	see appendix "Accessories"
17 5100 00	Back box partition wall, 1-gang	see appendix "Accessories"
70 0807 00	Connector, 3-pole	see appendix "Accessories"

Staff presence switch

77 0212 00...

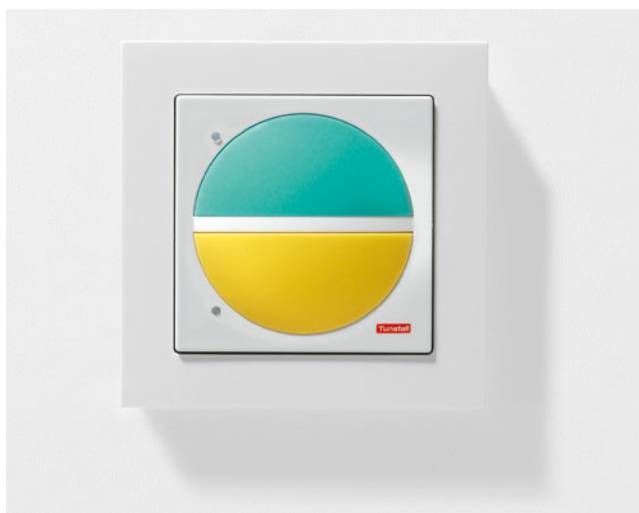

77 0212 00 A

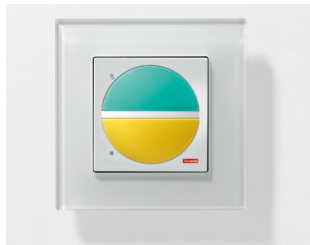

77 0212 00 C

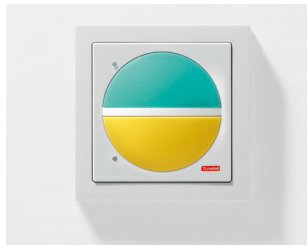

77 0212 00 F

General description

Water protected switch with two presence buttons with reminder light for switching on and off the staff presence for two different staff groups.

The special design indicates the switch also optically as part of the nurse call system.

Preferably designed for wall mounting.

Specification

- Green presence button for staff 1 with reminder light, green LED
- Yellow presence button for staff 2 with reminder light, yellow LED
- While staff presence is switched on: Acoustic signalling of forwarded calls and acoustic signalling of announcements (This function is disabled in the factory setting).
- Easy plug and play installation
- Large touch pads for easy operation
- Standard set to channel 0
- Integrated electronic processor for 3-pole plug-in connection to the room bus (RAN)
- Switch module with locking hooks for fixing on the support ring
- Support ring for screw fixing on a 1-gang back box
- Attractive design frame

Technical data

Power supply:	24 V DC
Standby current:	8 mA
Power supply:	24 V DC
Colour:	Studio white, similar to RAL 9016
Housing material:	Polycarbonate
Standby current:	8 mA

Order number	Product name	Notes
77 0212 00 A	Staff presence switch	Dimensions (HxWxD): 91 x 91 x 36 mm
77 0212 00 C	Staff presence switch	Design frame made of white glass Dimensions (HxWxD): 107 x 107 x 36 mm
77 0212 00 F	Staff presence switch	Dimensions (HxWxD): 80 x 80 x 36 mm
Necessary accessories, order separately:		
17 0100 00	Back box solid wall, 1-gang	see appendix "Accessories"
17 5100 00	Back box partition wall, 1-gang	see appendix "Accessories"
70 0807 00	Connector, 3-pole	see appendix "Accessories"

Cancel switch/WC

77 0213 00...



77 0213 00 A



77 0213 00 C



77 0213 00 F

General description

Water protected switch with two cancel buttons with reminder light for cancelling WC calls and WC emergency calls. An integrated beeper for acoustic signalling of forwarded calls, while staff presence is switched on in the room.

The special design indicates the switch also optically as part of the nurse call system.

Preferably designed for wall mounting.

Specification

- 2 grey cancel buttons with reminder light, yellow LED
- Easy plug and play installation
- Large touch pads for easy operation
- While staff presence is switched on: Acoustic signalling of forwarded calls and acoustic signalling of announcements (This function is disabled in the factory setting).
- Standard set to channel 0
- Integrated electronic processor for 3-pole plug-in connection to the room bus (RAN)
- Switch module with locking hooks for fixing on the support ring
- Support ring for screw fixing on a 1-gang back box
- Attractive design frame

Technical data

Power supply:	24 V DC
Standby current:	8 mA
Colour:	Studio white, similar to RAL 9016
Housing material:	Polycarbonate

Order number	Product name	Notes
77 0213 00 A	Cancel switch/WC	Dimensions (HxWxD): 91 x 91 x 36 mm
77 0213 00 C	Cancel switch/WC	Design frame made of white glass Dimensions (HxWxD): 107 x 107 x 36 mm
77 0213 00 F	Cancel switch/WC	Dimensions (HxWxD): 80 x 80 x 36 mm
Necessary accessories, order separately:		
17 0100 00	Back box solid wall, 1-gang	see appendix "Accessories"
17 5100 00	Back box partition wall, 1-gang	see appendix "Accessories"
70 0807 00	Connector, 3-pole	see appendix "Accessories"

Cardiac alarm switch

77 0214 00...



77 0214 00 A



77 0214 00 C



77 0214 00 F

General description

Water protected switch with two alarm buttons with reassurance light for raising cardiac alarms, while the staff presence is switched on in the room. The reassurance

lights are on with a bright light, when a cardiac alarm was raised.

The special design indicates the switch also optically as part of the nurse call system.

Preferably designed for wall mounting.

Specification

- 2 blue alarm buttons with reassurance light and integrated night location light, red LED
- The night location lights are on, while staff presence is switched on in the room
- Easy plug and play installation
- Understandable labelling through clear symbol
- Large touch pads for easy operation
- Standard set to channel 0
- Integrated electronic processor for 3-pole plug-in connection to the room bus (RAN)
- Switch module with locking hooks for fixing on the support ring
- Support ring for screw fixing on a 1-gang back box
- Attractive design frame

Technical data

Power supply:	24 V DC
Standby current:	8 mA
Colour:	Studio white, similar to RAL 9016

Order number	Product name	Notes
77 0214 00 A	Cardiac alarm switch	Dimensions (HxWxD): 91 x 91 x 36 mm
77 0214 00 C	Cardiac alarm switch	Design frame made of white glass Dimensions (HxWxD): 107 x 107 x 36 mm
77 0214 00 F	Cardiac alarm switch	Dimensions (HxWxD): 80 x 80 x 36 mm
Necessary accessories, order separately:		
17 0100 00	Back box solid wall, 1-gang	see appendix "Accessories"
17 5100 00	Back box partition wall, 1-gang	see appendix "Accessories"
70 0807 00	Connector, 3-pole	see appendix "Accessories"

Pull cord call switch

77 0215 00...

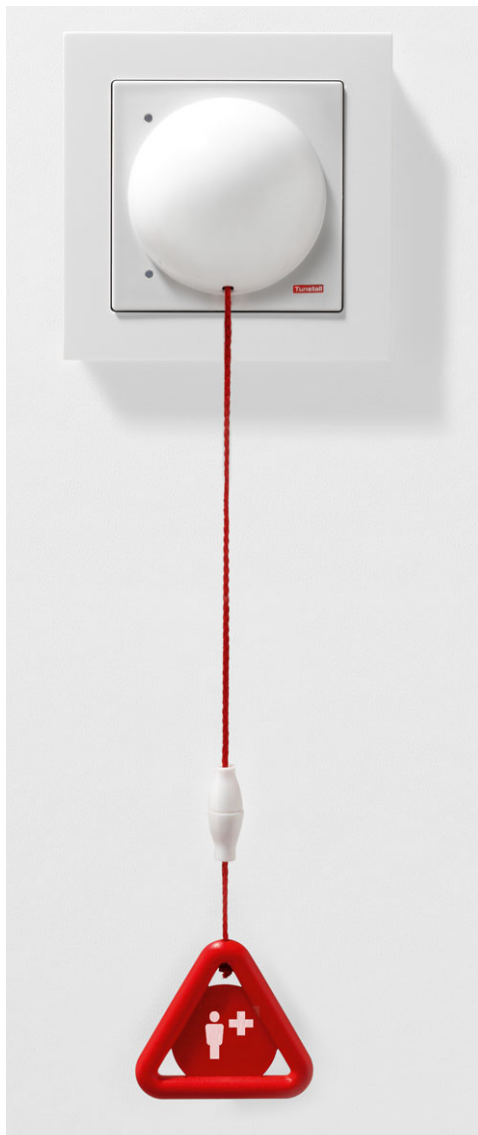

77 0215 00 A



77 0215 00 C



77 0215 00 F

General description

Water protected switch with a red pull cord and call handle for raising calls. Two reassurance lights are on with a bright light, when a call was raised. For additional reassurance a beep sounds when a call is raised. While staff presence is switched on in the room, an emergency call is raised.

The special design indicates the switch also optically as part of the nurse call system.

Suitable for wall mounting.

Specification

- 2.50 m pull cord and call handle with symbol
- 2 red LEDs with two functions as reassurance and night location light
- A beep sounds when a call is raised
- Easy plug and play installation
- Standard set to channel 0
- Integrated electronic processor for 3-pole plug-in connection to the room bus (RAN)
- Switch module with locking hooks for fixing on the support ring
- Support ring for screw fixing on a 1-gang back box
- Attractive design frame

Pull cord call switch

77 0215 00...

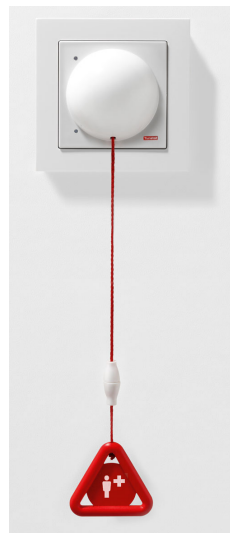

77 0215 00 A



77 0215 00 C



77 0215 00 F

Technical data

Power supply:	24 V DC
Standby current:	9 mA
Colour:	Studio white, similar to RAL 9016
Housing material:	Polycarbonate
Pull cord material:	Polyamide
Call handle material:	ABS

Order number	Product name	Notes
77 0215 00 A	Pull cord call switch	Dimensions (HxWxD): 91 x 91 x 56 mm
77 0215 00 C	Pull cord call switch Design frame made of white glass	Dimensions (HxWxD): 107 x 107 x 56 mm
77 0215 00 F	Pull cord call switch	Dimensions (HxWxD): 80 x 80 x 56 mm
Necessary accessories, order separately:		
17 0100 00	Back box solid wall, 1-gang	see appendix "Accessories"
17 5100 00	Back box partition wall, 1-gang	see appendix "Accessories"
70 0807 00	Connector, 3-pole	see appendix "Accessories"

Pull cord call switch/WC

77 0215 01...

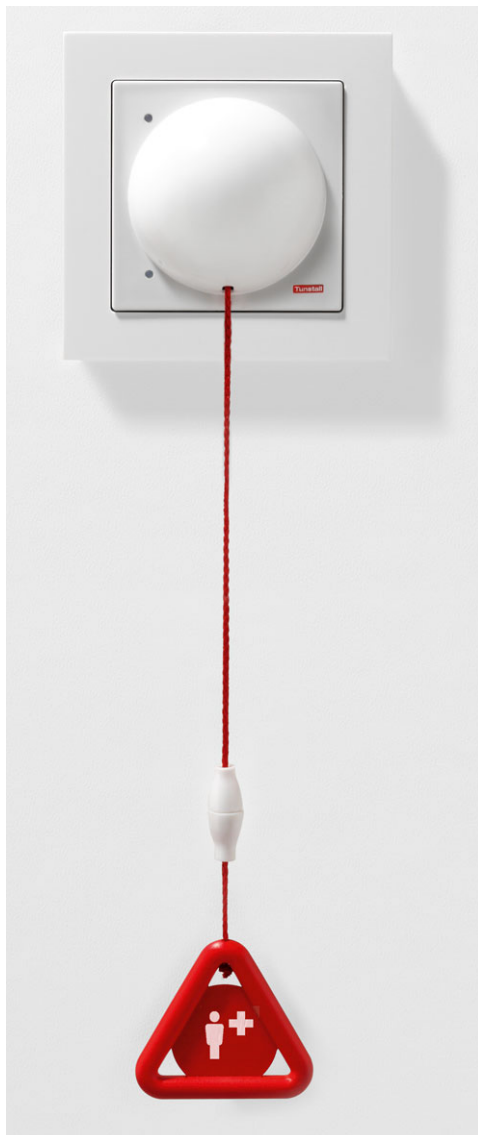

77 0215 01 A

General description

Water protected switch with a red pull cord and call handle for raising WC calls. Two reassurance lights are on with a bright light, when a WC call was raised. For additional reassurance a beep sounds when a WC call is raised. While staff presence is switched on in the room, a WC emergency call is raised. The special design indicates the switch also optically as part of the nurse call system.

Suitable for wall mounting.

Specification

- 2.50 m pull cord and call handle with symbol
- 2 red LEDs with two functions as reassurance and night location light
- A beep sounds when a call is raised
- Easy plug and play installation
- Standard set to channel 0
- Integrated electronic processor for 3-pole plug-in connection to the room bus (RAN)
- Switch module with locking hooks for fixing on the support ring
- Support ring for screw fixing on a 1-gang back box
- Attractive design frame



77 0215 01 C



77 0215 01 F

Pull cord call switch/WC

77 0215 01...

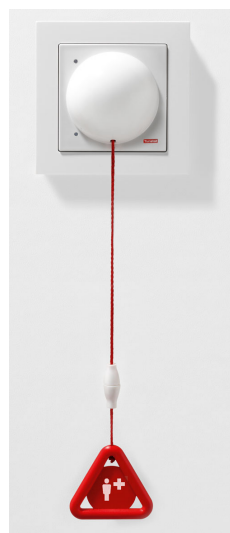

77 0215 01 A



77 0215 01 C

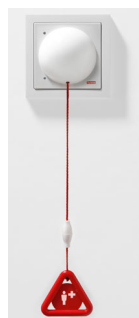

77 0215 01 F

Technical data

Power supply:	24 V DC
Standby current:	9 mA
Colour:	Studio white, similar to RAL 9016
Housing material:	Polycarbonate
Pull cord material:	Polyamide
Call handle material:	ABS

Order number	Product name	Notes
77 0215 01 A	Pull cord call switch/WC	Dimensions (HxWxD): 91 x 91 x 56 mm
77 0215 01 C	Pull cord call switch /WC Design frame made of white glass	Dimensions (HxWxD): 107 x 107 x 56 mm
77 0215 01 F	Pull cord call switch/WC	Dimensions (HxWxD): 80 x 80 x 56 mm
Necessary accessories, order separately:		
17 0100 00	Back box solid wall, 1-gang	see appendix "Accessories"
17 5100 00	Back box partition wall, 1-gang	see appendix "Accessories"
70 0807 00	Connector, 3-pole	see appendix "Accessories"

Pneumatic call switch

77 0216 00...



77 0216 00 A



77 0216 00 C



77 0216 00 F

General description

Water protected switch with an air hose and a red rubber ball for raising calls by squeezing the bulb. Two reassurance lights are on with a bright light, when a call was raised. For additional reassurance a beep sounds when a call is raised. While staff presence is switched on in the room, an emergency call is raised.

The special design indicates the switch also optically as part of the nurse call system.

Preferably designed for wall mounting.

Specification

- 2 m air hose with red bulb made of soft PVC
- 2 red LEDs with two functions as reassurance and night location light
- A beep sounds when a call is raised
- Easy plug and play installation
- Standard set to channel 0
- Integrated electronic processor for 3-pole plug-in connection to the room bus (RAN)
- Switch module with locking hooks for fixing on the support ring
- Support ring for screw fixing on a 1-gang back box

Pneumatic call switch

77 0216 00...

- Page 2 -



77 0216 00 A

Technical data

Power supply:	24 V DC
Standby current:	14 mA
Colour:	Studio white, similar to RAL 9016
Housing material:	Polycarbonate
"Rubber" bulb material:	Soft PVC



77 0216 00 C



77 0216 00 F

Order number	Product name	Notes
77 0216 00 A	Pneumatic call switch	Dimensions (HxWxD): 91 x 91 x 56 mm
77 0216 00 C	Pneumatic call switch	Design frame made of white glass Dimensions (HxWxD): 107 x 107 x 56 mm
77 0216 00 F	Pneumatic call switch	Dimensions (HxWxD): 80 x 80 x 56 mm
Necessary accessories, order separately:		
17 0100 00	Back box solid wall, 1-gang	see appendix "Accessories"
17 5100 00	Back box partition wall, 1-gang	see appendix "Accessories"
70 0807 00	Connector, 3-pole	see appendix "Accessories"

Pneumatic call switch/WC

77 0216 01...



77 0216 01 A



77 0216 01 C



77 0216 01 F

General description

Water protected switch with an air hose and a red rubber ball for raising WC calls by squeezing the bulb. Two reassurance lights are on with a bright light, when a WC call was raised. For additional reassurance a beep sounds when a WC call is raised. While staff presence is switched on in the room, a WC emergency call is raised.

The special design indicates the switch also optically as part of the nurse call system.

Preferably designed for wall mounting.

Specification

- 2 m air hose with red bulb made of soft PVC
- 2 red LEDs with two functions as reassurance and night location light
- A beep sounds when a call is raised
- Easy plug and play installation
- Standard set to channel 0
- Integrated electronic processor for 3-pole plug-in connection to the room bus (RAN)
- Switch module with locking hooks for fixing on the support ring
- Support ring for screw fixing on a 1-gang back box

Pneumatic call switch/WC

77 0216 01...

- Page 2 -



77 0216 01 A

Technical data

Power supply:	24 V DC
Standby current:	14 mA
Colour:	Studio white, similar to RAL 9016
Housing material:	Polycarbonate
"Rubber" bulb material:	Soft PVC



77 0216 01 C



77 0216 01 F

Order number	Product name	Notes
77 0216 01 A	Pneumatic call switch/WC	Dimensions (HxWxD): 91 x 91 x 56 mm
77 0216 01 C	Pneumatic call switch/WC Design frame made of white glass	Dimensions (HxWxD): 107 x 107 x 56 mm
77 0216 01 F	Pneumatic call switch/WC	Dimensions (HxWxD): 80 x 80 x 56 mm
Necessary accessories, order separately:		
17 0100 00	Back box solid wall, 1-gang	see appendix "Accessories"
17 5100 00	Back box partition wall, 1-gang	see appendix "Accessories"
70 0807 00	Connector, 3-pole	see appendix "Accessories"

Call switch/WC with cancel switch

77 0217 00...



77 0217 00 A



77 0217 00 C



77 0217 00 F

General description

Water protected switch with call button with reassurance light for raising WC calls. The reassurance light is on with a bright light, when a call was raised. While staff presence is switched on in the room, a WC emergency call is raised. Furthermore the switch is equipped with a cancel button for cancelling WC calls and WC emergency calls.

The special design indicates the switch also optically as part of the nurse call system.

Preferably designed for wall mounting.

Specification

- Red call button with symbol with reassurance light and integrated night location light, red LED
- Grey cancel button with reminder light, yellow LED
- While staff presence is switched on: Acoustic signalling of forwarded calls and acoustic signalling of announcements (This function is disabled in the factory setting).
- Easy plug and play installation
- Large touch pads for easy operation
- Standard set to channel 0
- Integrated electronic processor for 3-pole plug-in connection to the room bus (RAN)
- Switch module with locking hooks for fixing on the support ring
- Support ring for screw fixing on a 1-gang back box
- Attractive design frame

Technical data

Power supply:	24 V DC
Standby current:	8.5 mA
Colour:	Studio white, similar to RAL 9016
Housing material:	Polycarbonate

Order number	Product name	Notes
77 0217 00 A	Call switch/WC with cancel switch	Dimensions (HxWxD): 91 x 91 x 36 mm
77 0217 00 C	Call switch/WC with cancel switch	Design frame made of white glass Dimensions (HxWxD): 107 x 107 x 36 mm
77 0217 00 F	Call switch/WC with cancel switch	Dimensions (HxWxD): 80 x 80 x 36 mm
Necessary accessories, order separately:		
17 0100 00	Back box solid wall, 1-gang	see appendix "Accessories"
17 5100 00	Back box partition wall, 1-gang	see appendix "Accessories"
70 0807 00	Connector, 3-pole	see appendix "Accessories"

Call switch with privacy switch

77 0218 00...



77 0218 00 A



77 0218 00 C



77 0218 00 F

General description

Water protected switch with call button with reassurance light for raising calls. The reassurance light is on with a bright light, when a call was raised. While staff presence is switched on in the room, an emergency call is raised. Furthermore the switch is equipped with a privacy button for switching on and off the pri-

vacy in the room.

The special design indicates the switch also optically as part of the nurse call system.

Preferably designed for wall mounting.

Specification

- Red call button with symbol with reassurance light and integrated night location light, red LED
- Grey privacy button for switching on and off the privacy in the room, even if staff presence is switched on in the room. The white LED is on, if the privacy was switched on with the privacy button
- Easy plug and play installation
- Large touch pads for easy operation
- Standard set to channel 0
- Integrated electronic processor for 3-pole plug-in connection to the room bus (RAN)
- Switch module with locking hooks for fixing on the support ring
- Support ring for screw fixing on a 1-gang back box
- Attractive design frame

Technical data

Power supply:	24 V DC
Standby current:	8.5 mA
Colour:	Studio white, similar to RAL 9016
Housing material:	Polycarbonate

Order number	Product name	Notes
77 0218 00 A	Call switch with privacy switch	Dimensions (HxWxD): 91 x 91 x 36 mm
77 0218 00 C	Call switch with privacy switch	Design frame made of white glass Dimensions (HxWxD): 107 x 107 x 36 mm
77 0218 00 F	Call switch with privacy switch	Dimensions (HxWxD): 80 x 80 x 36 mm
Necessary accessories, order separately:		
17 0100 00	Back box solid wall, 1-gang	see appendix "Accessories"
17 5100 00	Back box partition wall, 1-gang	see appendix "Accessories"
70 0807 00	Connector, 3-pole	see appendix "Accessories"

Staff presence combination with call tone

77 0219 00...



77 0219 00 A



77 0219 00 C

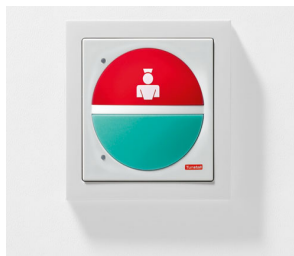

77 0219 00 F

General description

Water protected switch with one presence button with reminder light for switching on and off the staff presence. Furthermore the switch is equipped with a call button with reassurance light for raising calls. The reassurance light is on with a bright light, when a call was raised. While staff presence is switched on in the

room, an emergency call is raised. An integrated beeper for acoustic signalling of forwarded calls, while staff presence is switched on in the room.

The special design indicates the switch also optically as part of the nurse call system.

Preferably designed for wall mounting.

Specification

- Green presence button for staff 1 with reminder light, green LED
- Red call button with symbol with reassurance light and integrated night location light, red LED
- While staff presence is switched on: Acoustic signalling of forwarded calls and acoustic signalling of announcement.
- Easy plug and play installation
- Large touch pads for easy operation
- Standard set to channel 0
- Integrated electronic processor for 3-pole plug-in connection to the room bus (RAN)
- Switch module with locking hooks for fixing on the support ring; Support ring for screw fixing on a 1-gang back box

Technical data

Power supply:	24 V DC
Standby current:	8.5 mA
Colour:	Studio white, similar to RAL 9016
Housing material:	Polycarbonate

Order number	Product name	Notes
77 0219 00 A	Staff presence combination with call tone	Dimensions (HxWxD): 91 x 91 x 36 mm
77 0219 00 C	Staff presence combination with call tone	Design frame made of white glass Dimensions (HxWxD): 107 x 107 x 36 mm
77 0219 00 F	Staff presence combination with call tone	Dimensions (HxWxD): 80 x 80 x 36 mm
Necessary accessories, order separately:		
17 0100 00	Back box solid wall, 1-gang	see appendix "Accessories"
17 5100 00	Back box partition wall, 1-gang	see appendix "Accessories"
70 0807 00	Connector, 3-pole	see appendix "Accessories"

IR TV control module universal

incl. cable set

77 0360 11



General description

Interface for the control of a standard TV set using infrared signals. A wide range of TV manufacturers and models are supported, e.g. LG, Philips, Samsung.

Integrated audio amplifier for driving an operator device. The output volume can be adjusted within predefined limits.

The adjustment of the audio level with the TV sets in use has to be taken into account.

Consisting of a control module and an infrared transmitting unit. Mounting directly to the IR input of the TV set.

For the configuration of the control signals the TV set model must be known.

Specification

- The following IR signal modes are supported: RC5/RC5X (e.g. Philips), RC6, SAMSUNG, LG/NEC
- Integrated interface to the room bus (RAN)
- Potential separation according to DIN VDE 0834 and DIN EN 60601-1
- 2 LEDs indicate the operating state
- Incl. cable set

Technical data

Dimensions (HxWxD): 35 x 135 x 90 mm
 Power supply: 24 V DC (from the nurse call system)
 Standby current consumption: 23 mA
 Weight (without cables): approx. 200 g

Order no.	Product name	Note
77 0360 11	IR TV control module universal	as described above
Necessary accessories, order separately:		
77 0360 40	IR TV control module installation kit	Only 1 piece required per project

TV audio amplifier

77 0365 00



General description

Audio amplifier for the distribution of audio signals to max. 4 listening points/beds.

Usable with TV sets with headphone jack.

All required connecting cables and fixing materials are included with delivery.

Specification

- Up to 4 listening points/beds
- Potential separation according to DIN VDE 0834 and DIN EN 60601-1
- Potentiometer with pin to the outside for volume control
- External 12 V power supply. NOTE TO THE INSTALLATION: A second mains socket is required per TV set for the TV audio amplifier.
- Power LED

Technical data

Dimensions (HxWxD): 27 x 86 x 70 mm

Weight (without cables): approx. 90 g

Power supply: via external 12 V power supply

Order no.	Product name	Note
77 0365 00	TV audio amplifier	as described above

ePat[®]lite

77 0370 00



General description

Combined communication and operating device with duplex speech facility for use at the patient bed as part of a nurse call system in accordance with DIN VDE 0834.

The detached, illuminated, clearly recognizable call button enables secure call triggering at any time.

Comfort functions are controlled via a touch-sensitive interface. Comfort functions include switching and dimming of 2 light sources, TV control and sound transmission, entertainment transmission as well as blinds control. The additional service call button makes it possible to request non-nursing services.

The clear arrangement and clear symbols of the operating elements ensure safe operation, especially in emergency situations.

High speech quality for open and discreet speech between patient and nursing staff.

Specification

- Ergonomically shaped housing, particularly suitable for patients with motor impairments
- Intuitive operation through simple, understandable symbols
- Excellent speech quality, high-quality microphone and high-quality loudspeaker
- Loudspeaker volume can be adjusted during speech connection
- Red call button incl. reassurance light and integrated location light
- Light key for reading light with location light
- Light key for room light
- Sound transmission (TV/entertainment) optional
- 2 keys for volume control TV/entertainment
- Key for switching TV on/off, status indicator
- Key for switching entertainment on/off and blinds control mode on, status indicator
- 2 keys for program selection TV/entertainment and lowering and raising the blinds
- Service call key for requesting services (system function in preparation, corresponding organisation on the ward or in the hospital provided, additional hardware and software components required)
- CLEAN key for locking the touch-sensitive user interface during cleaning
- 1 headphone socket (3.5 mm jack) for connecting a standard headphone (32 Ohm)
- Connection cable with robust plug, approx. 2.5 m
- Mounting bracket for the ePat[®]lite
- Operating surface with antibacterial effect
- Moisture protection for easy cleaning and disinfection

ePat[®]lite

77 0370 00

- Page 2 -



System requirements

- Plug connection to connection socket combi, order no. 70 0425 00 or 70 0424 00, or to connection socket combi, bedhead unit, order no. 70 0435 00 or 70 0434 00
- TV control in combination with RAN interface, order no. 77 0840 00
- Blinds control in connection with RAN interface universal, order no. 70 0848 00

Scope of supply

- ePat[®]lite
- Mounting bracket for ePat[®]lite
- Instructions for use for patients
- Cleaning notes

Technical data

Dimensions (HxWxD):	173 x 65 x 27 mm
Power supply:	24 V DC
Standby current consumption:	40 mA
Weight incl. cable:	190 g
Colour:	white/black
Housing, call button and mounting bracket material:	ASA/PC
Operating surface material:	ABS with PET coating with antibacterial properties
Connection cable, plug:	Soft PVC

Order no.	Product name	Note
77 0370 00	ePat [®] lite	as described above
Optional accessories, order if required:		
70 0801 00	Headphone	see appendix "Accessories"

ManagementCenter^{PC}

77 0610 00

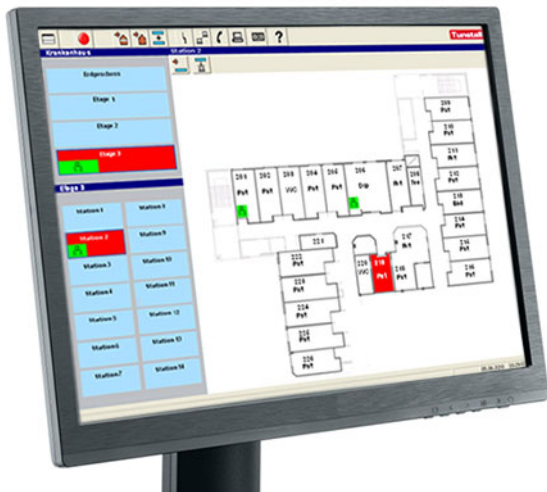

General description

Screen based central console for central processing of all functions within the nurse call system.

Separate arrangement of control and operating unit. Ergonomic design as a PC workstation, furnished with all components required for its full operation. Operation unit designed for desktop installation.

Ready for the operation with the Flamenco system family.

In a system with IP-SystemManagers, the ManagementCenter^{PC} is prepared for connection to a separate IP-SystemManager with the VOIP GATE function module and to the IP network of the nurse call system. In a system with OSY-ControlCenter the ManagementCenter^{PC} is pre-equipped for connection to the OSY-ControlCenter.

Components

- Speech communication via desktop speech unit with integrated handset
- Interface to the system computer
- System computer (order no. 80 6010 00D)
- LCD monitor 19" (order no. 80 6049 00)
- UPS 600 VA/360 W (order no. 21 9000 00)
- PrimusGlobal+ "ManagementCenter^{PC}" (order no. 77 0700 00)
- Additional software modules available.

Features (extract)

Display and processing of nurse call system's installed functions:

- Normal calls, emergency calls, cardiac alarm (code blue)
- Display of caller's location
- Staff presence
- Bed identification
- Call status (fresh / answered)

Additional information

- Date / time
- Speech control and speech status
- Technical system messages
- External system messages via interfaces

Announcements

- Flexible set-up of announcements, arranged according to rooms, wards, areas, as single or collective announcements, to all rooms or only to rooms with activated staff presence

Control of operating modes

- Centralised mode / ward mode
- Ward coupling
- Free definable operating modes

ManagementCenter^{PC}

77 0610 00

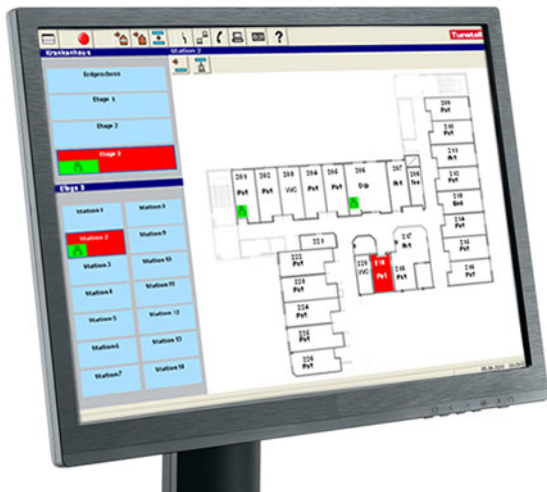

Software support contract

The acquiring of the system software PrimusGlobal+ is combined with placing of a software administration contract with costs. The administration contract is an important prerequisite for an optimal and long-term use of the user software

Scope of services:

- Regular updates of PrimusGlobal+ software
- Revisions in configuration and adaptations to ongoing developments
- Remote maintenance: Comfortable error analysis and correction online
- Telephone hotline during business hours of Tunstall GmbH

Order no.	Product name	Note
77 0610 00	ManagementCenter ^{PC}	
Necessary accessories, order separately:		
76 2100 00	IP-SystemManager	see appropriate data sheet
76 0743 00	Function module VOIP GATE	see appropriate data sheet
Required services, order separately:		
77 0790 00	PrimusGlobal+ System set-up & configuration	see appendix "Services"
77 0790 01	PrimusGlobal+ project data, block graphics	see appendix "Services"
77 0790 02	PrimusGlobal+ project data, layout graphics	see appendix "Services"

PrimusGlobal+ “ManagementCenter”

77 0700 00

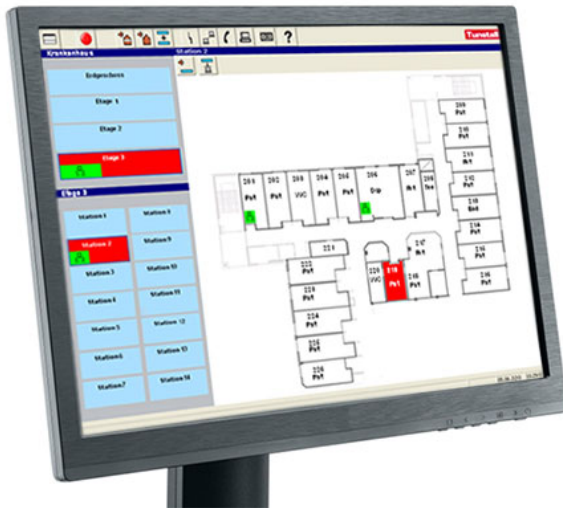

General description

PrimusGlobal+ “ManagementCenter” is a software especially for central consoles in nurse call systems of the Flamenco system family. All features for central processing of all nurse call system functions are provided, easy to operate.

Wards and rooms can be displayed as simple graphic elements or on the basis of floor plans.

Several console workstations can work in a network compound. To support call handling person related data, such as care data, name, extension number, can be accessed.

All system events can be recorded and stored, filtered and exported to other applications.

As supplement other modules from the Primus-Global+ software family are available.

Linking to the nurse call system is function-monitored in compliance with DIN VDE 0834.

Basis

- Microsoft Windows operating system
- Data interface the control unit
- Data base for storing all system data and customer specific data
- Software interface for remote maintenance of the system
- User interface to the nurse call system
- Graphic display of wards, areas and rooms, hierarchically structured.
- Texts and graphics scalable

Features (extract)

Display and processing of calling system’s installed functions:

- Normal calls, emergency calls, cardiac alarm (code blue)
- Display of caller’s location
- Staff presence
- Bed identification
- Call status (fresh / answered)

Additional information

- Date / time
- Speech control and speech status
- Technical system messages
- External system messages via interfaces

Announcements

- Flexible set-up of announcements, arranged according to rooms, wards, areas, as single or collective announcements, to all rooms or only to rooms with activated staff presence

Control of operating modes

- Centralised mode / ward mode
- Ward coupling
- Free definable operating modes

PrimusGlobal+ “ManagementCenter”

77 0700 00

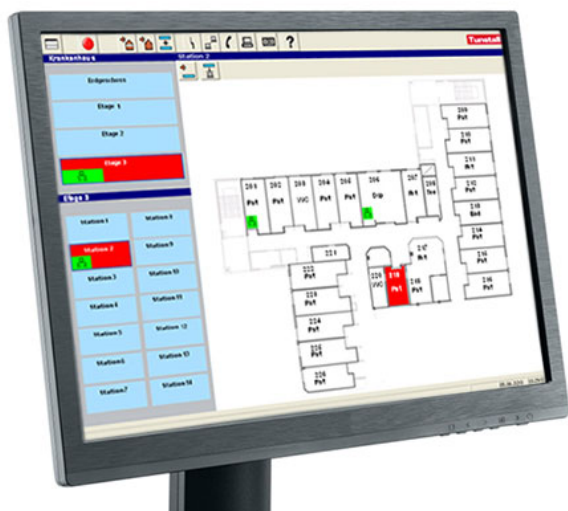

Multi-station operation

The connected wards can be allocated to several call handling stations. The system allows for the distribution to several work stations but also the concentration on one console (e.g. during night shifts).

Care data

A database for saving, processing and documenting of person-related care data is provided in support of call handling. The data may comprise details such as

names, nursing information and other practical data for the use by nursing staff. Data management takes place directly from the call handling console.

Call recording

To support care documentation, all call data, presence of staff, and system events can be recorded. Data storage is effected with date, time plus relevant information as to the data source such as ward and room. Filtering and sorting of data can be selected for numerous combinations of criteria.

Software support contract

The acquiring of the system software PrimusGlobal+ is combined with placing of a software administration contract with costs. The administration contract is an important prerequisite for an optimal and long-term use of the user software

Scope of services:

- Regular updates of PrimusGlobal+ software
- Revisions in configuration and adaptations to ongoing developments
- Remote maintenance: Comfortable error analysis and correction online
- Telephone hotline during business hours of Tunstall GmbH

Order no.	Product name	Note
77 0700 00	PrimusGlobal+ “ManagementCenter”	
Required services, order separately:		
77 0790 00	PrimusGlobal+ System set-up & configuration	see appendix “Services”
77 0790 01	PrimusGlobal+ project data, block graphics	see appendix “Services”
77 0790 02	PrimusGlobal+ project data, layout graphics	see appendix “Services”

PrimusGlobal+ “Call recording”

77 0710 00

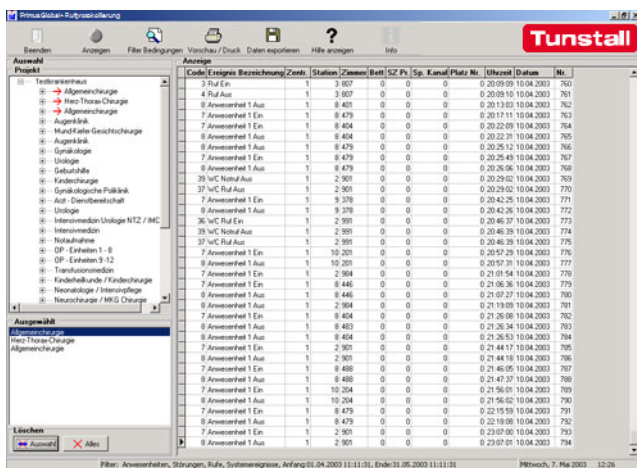

General description

PrimusGlobal+ “Call recording” is a software for nurse call systems of the Flamenco system family for supporting the care documentation.

All call data, staff registrations and system events are recorded. Data storage is effected with date, time plus relevant information as to the data source such as ward or room.

Filtering and sorting of data can be selected for numerous combinations of criteria.

For succeeding post-processing and analysis there is an export function to convenient office applications.

Basis

- Microsoft Windows operating system
- Data interface to the Flamenco nurse call system
- Data base for storing all system data and customer specific data
- Software interface for remote maintenance of the system
- User interface to the nurse call system

Features

- Permanent recording of all system events
- Selection of locations (wards, rooms etc.) to analyse
- Filtering data according to event time
- Filtering data according to event type (calls, presences, other events)
- Filtering data according to actions taken
- Selection of parameter for display
- Sorting the data
- Print feature
- Export feature to convenient office packages, CSV format.

Software support contract

The acquiring of the system software PrimusGlobal+ is combined with placing of a software administration contract with costs. The administration contract is an important prerequisite for an optimal and long-term use of the user software

Scope of services:

- Regular updates of PrimusGlobal+ software
- Revisions in configuration and adaptations to ongoing developments
- Remote maintenance: Comfortable error analysis and correction online
- Telephone hotline during business hours of Tunstall GmbH

Order no.	Product name	Note
77 0710 00	PrimusGlobal+ “Call recording”	
Required services, order separately:		
77 0790 00	PrimusGlobal+ System set-up & configuration	see appendix “Services”

PrimusGlobal+ “Connect” module

77 0720 00

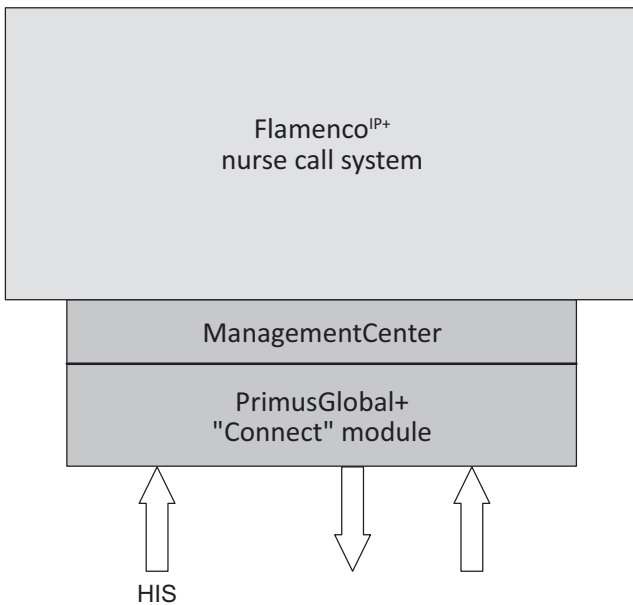

General description

The PrimusGlobal+ software family effectively complements nurse call systems of the Flamenco system family. The “Connect” module is a supplement to PrimusGlobal+ “ManagementCenter”. The “Connect” module provides interfaces to other systems like hospital information system (HIS).

Applications / drivers

Depending on the respective application appropriate drivers are used.

HL7

Care data and/or personal data to be used at call handling consoles within the nurse call system can be taken from hospital information system (HIS).

Order no.	Product name	Note
77 0720 00	PrimusGlobal+ “Connect” module	as described above
System driver, to be ordered separately:		
77 0720 01	PrimusGlobal+ system driver HL7	see appropriate data sheet

PrimusGlobal+ system driver HL7

77 0720 01

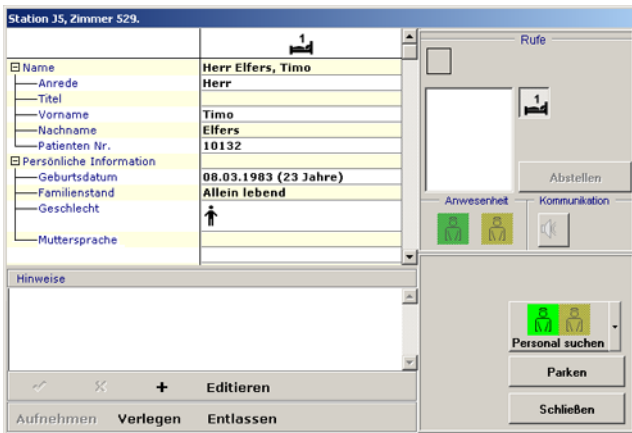

General description

The PrimusGlobal+ software family effectively complements nurse call systems of the Flamenco system family. Special system drivers supplement the “Connect” module with additional interfaces and performance features.

The system driver HL7 links the hospital information system (HIS) to the PrimusGlobal+ software family.

Defined data fields from the HL7 data record are accepted and then are ready for further display at the ManagementCenter.

The information to be transferred is selected in agreement with the customer.

Different transfer protocols and transfer methods can be supported. Depending on the amount of work additional costs for adaptation developments may incur. The costing is made after the specification sheet is approved.

Order no.	Product name	Note
77 0720 01	PrimusGlobal+ system driver HL7	

SystemOrganizer

77 0750 00

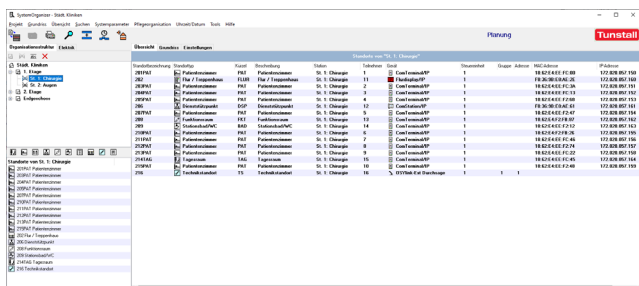

General description

The SystemOrganizer software is a planning and configuration tool for the Flamenco system family. It provides the user interface to the control unit and enables the complete parameter setting for the nurse call system.

The handling and the subdivision follows Flamenco's basic principle. The physical parameters are strictly separated from the organisational assignments.

The access is password protected by 5 different user levels. Herewith is ensured, that each user group (planning office, care management...) can only make the settings, which are relevant for him/her.

Right from the planning stage the SystemOrganizer is used to enter the project structures of buildings, wards and rooms. All parameters can be modified every time to adapt to the respective needs.

When using the data from the beginning of the planning over the whole life cycle of the system it will never be necessary to enter data twice. All data can be copied, saved and read out from a nurse call system.

System planning

- Construction of the basic structure of buildings, wards, rooms
- Plan view presentation
- Screen shot directly from the screen
- Import of existing graphics
- Choosing pre-set room types
- Free allocation of room numbers and designations
- Easy handling by drag-and-drop
- Guided planning process
- Printable survey of buildings, wards, rooms

Operation

- Interactive and user guided handling
- 5 user levels, password protection
- 2 display levels (physical, organisational structure)
- Access to all system and project data, tree structure
- Administration of several projects and archiving the data
- Readout of the project configuration in the running project, display of the configuration
- Plausibility check for data entry

Configuration

- Country-specific settings
- Setting date and time
- Hierarchic structure of buildings, wards and rooms
- Assignment of addresses rooms and peripherals
- Designations and room numbers for rooms, wards, buildings, etc.
- Setting call types and system messages
- Signalling options e.g. tone and flash-signal sequences
- Parameters for call handling e.g. call types, call categories, call cancelling, privacy

SystemOrganizer

77 0750 00

- Page 2 -

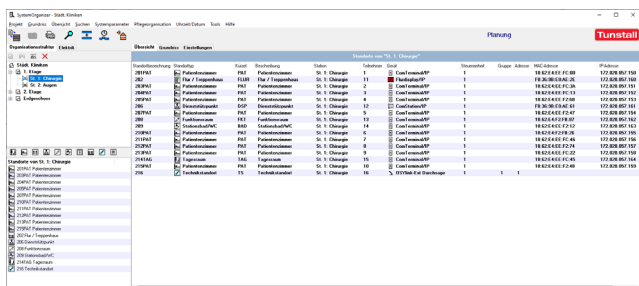

Configuration (continuation)

- Defining announcements for rooms, wards and areas
- Organisational assignment of rooms (locations) to wards, shifts, etc.
- Defining ward couplings
- Parameter setting for escalation procedures for call handling
- Administration of interfaces to external systems
- Administration of cordless telephony devices (DECT/radio paging system/WLAN)
- Setting all system parameters including the administration of integrated networks and IP addresses

Requirements

- Operating system: Microsoft Windows 10 (32 Bit, 64 Bit)
- 10/100 Mbit LAN access
- Software training "SystemOrganizer"

Order no.	Product name	Note
77 0750 00	SystemOrganizer	
Required training, order separately:		
	Software training "SystemOrganizer"	Successful completing the training is a mandatory condition for using the SystemOrganizer.

OSYlink-Universal

77 0803 00

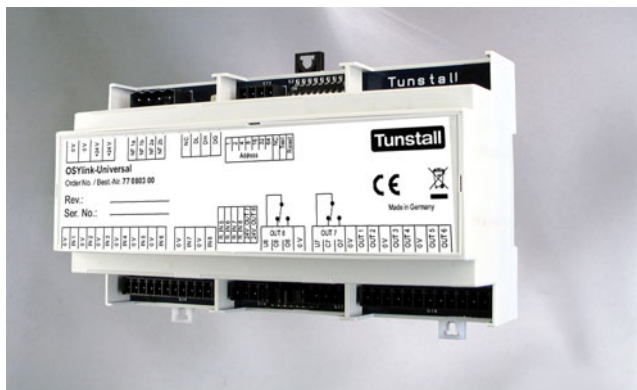

General description

Interface for connecting external systems and/or technical installations to the group bus OSYnet.

Specification

- 4 monitored inputs:
 - 2 x Call
 - 1 x Emergency call
 - 1 x Cardiac alarm (code blue)
- 1 input: collective announcement (all wards)
- 1 input: collective announcement (all presences)
- 1 input „Initiate calla 1 associated input „Cancel call“
- 4 solid state outputs, configurable:
 - Collective output Calls
 - Collective output Emergency calls
 - Collective output Cardiac alarms (code blue)
- 2 solid state outputs, can be configured
- 1 output with location light feature, configurable (functionally associated to one input)
- 2 potential free outputs, configurable (change-over contact, voltage source selectable by jumper)
- Central, flexible configuration of the outputs
- Mounting on wall or top-hat rail (35 mm), several units can be mounted side-by-side
- Outputs short-circuit and overload protected

Technical data

Dimensions (HxWxD):	90 x 160 x 58 mm
Power supply:	24 V DC
Standby current consumption	
(all outputs OFF):	40 mA
Max. current consumption (all outputs ON):	100 mA
Colour:	RAL 7035 light grey
Housing material:	Polycarbonate UL94 V-0
Ingress protection code:	IP20

Order no.	Product name	Note
77 0803 00	OSYlink-Universal	
Optional accessories, order if required:		
00 0276 54	ESD protection cover "long"	

OSYlink-Announcement

77 0804 00

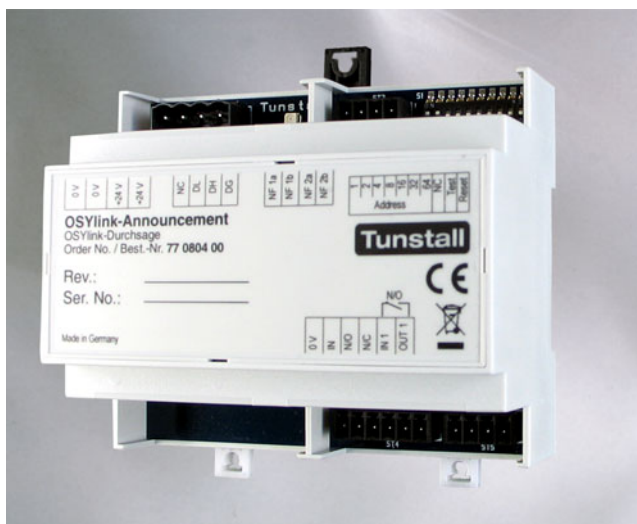

General description

Interface for connecting a maximum of 5 loudspeakers with announcement interface, order no. 05 0024 01, or a maximum of 4 1-channel-audio-amplifiers 100 V / 25 W, order no. 00 0647 13, to the group bus OSYnet.

Specification

- 1 audio output for driving the active loudspeakers or the audio amplifiers
- 1 potential-free digital output for control of signalling the activity of the active loudspeakers
- Mounting on wall or top-hat rail (35 mm), several units can be mounted side-by-side
- Output short-circuit and overload protected

Technical data

Dimensions (HxWxD):	90 x 106 x 58 mm
Power supply:	24 V DC
Standby current consumption:	32 mA
Max. Current consumption:	60 mA
Colour:	RAL 7035 light grey
Housing material:	Polycarbonate UL94 V-0
Ingress protection code:	IP20

Order no.	Product name	Note
77 0804 00	OSYlink-Announcement	
Optional accessories, order if required:		
00 0276 53	ESD protection cover "short"	see appendix "Accessories"

RAN interface

77 0840 00

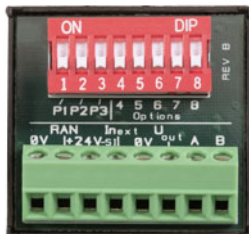

General description

The RAN interface is intended for the connection of a third-party device to the room bus (RAN).

A top-hat rail clip for mounting the RAN interface on a top-hat rail is included with the delivery.

Possible applications

External call device initiates the call type “Call”

- Call button as normally closed or normally open contact
- Minimum switching current for the button: 0.1 mA, 5 V DC
- Bed number can be set
- Mode of call cancellation can be configured: Call cancelling within the nurse call system or automatically, when the call device is reset.
- Location light can be connected ($I_{max} = 0.5 \text{ mA}$). When a call is initiated, it is on with a bright light as reassurance light.

External call device initiates the call type “Cardiac alarm”

- Alarm button as normally closed or normally open contact
- Minimum switching current for the button: 0.1 mA, 5 V DC
- Bed number can be set
- Mode of alarm cancellation can be configured: Alarm cancelling within the nurse call system or automatically, when the alarm device is reset.

- Location light can be connected ($I_{max} = 0,5 \text{ mA}$). When a cardiac alarm is initiated, it is on with a bright light as reassurance light.

External call device initiates the call type “WC call”

- Call button as normally closed or normally open contact
- Minimum switching current for the button: 0.1 mA, 5 V DC
- A channel number can be assigned to form functional units
- Location light can be connected ($I_{max} = 0.5 \text{ mA}$). When a WC call is initiated, it is on with a bright light as reassurance light.

External presence switch for staff presence 1:

- Presence button as normally closed or normally open contact
- Minimum switching current for the button: 0.1 mA, 5 V DC
- A channel number can be assigned to form functional units

TV set is controlled using ePat^{®lite} or patient handset

- Using ePat^{®lite} or patient handset and connection socket combi (order no. 70 0425 00, 70 0424 00) / connection socket combi, bedhead unit (order no. 70 0435 00, 70 0434 00) patient TV can be controlled.

Technical data

Dimensions (HxWxD):	32 x 34 x 16 mm (without clip)
Power supply:	24 V DC
Standby current consumption:	8 mA
Weight:	13 g (without clip)

RAN interface

77 0840 00

- Page 2 -

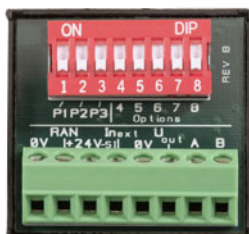

Order no.	Product name	Note
77 0840 00	RAN interface	

OSYlink AS-CCS

77 0870 00



General description

Universal interface for the compatible connection of CCS systems to the Flamenco system family.

Intended for installation in ward distribution cabinets or installation rooms.

The interface transforms the data and speech signals of previous CCS systems into compatible signals for the Flamenco system. This way, it is possible to run individual wards using CCS technology in a Flamenco system environment.

The operating mode is adjustable by a coding switch.

Important note

Existing projects are often complex in structure (project history, customized solutions, existing cabling, etc.) That's why the functionality has to be checked in case of using the OSYlink AS-CCS for each single project.

Important note

For connecting a half-duplex speech system additionally a speech amplifier with the power supply unit is required. It will be controlled by the OSYlink AS-CCS via defined contacts.

Specification

- Data and speech connection to the OSYnet
- Data and speech connection to the CCS bus
- Switching inputs and outputs for control of an external speech amplifier
- Conversion of all needed system functions
- System configuration via OSYnet (SystemOrganizer)
- Operation and function indicators
- Plug-in connections
- Mounting on top-hat rail (35 mm)

Technical data

Dimensions (HxWxD):	90 x 160 x 58 mm
Power supply:	24 V DC
Max. current consumption:	90 mA
Colour:	RAL 7035 light grey
Housing material:	Polycarbonate UL94 V-0
Ingress protection code:	IP20

Order no.	Product name	Note
77 0870 00	OSYlink AS-CCS	
Optional accessories, order if required:		
00 0276 54	ESD protection cover "long"	see appendix "Accessories"

RAN interface with speech

77 0880 00

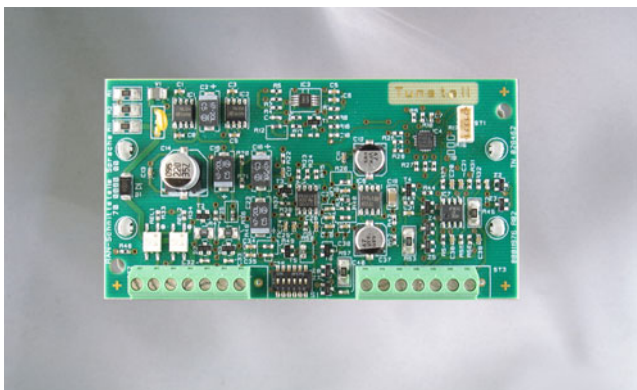

General description

Interface for the connection of analogue speech systems per bed to the room bus (RAN). Telephones or other devices with speech can be used as patient units, provided that they comply with the specification for the connection. The patient unit to be used has to be approved by Tunstall GmbH.

The principle of the connection is based on the integration of the microphone, loudspeaker, and call button into the patient unit and an appropriate interface.

Additionally to the standard application it is possible to use the interface in parallel to an existing ePat[®]lite or Tunstall patient handset. In this case different operation modes can be realized.

Specification

- Interface to the room bus (RAN)
- Assignment to the bed possible incl. bed identification 1 – 6, DIP switch
- Input for the monitored connection of a call button
- Disconnection of the patient unit is registered. A call will be raised automatically.
- Output for the connection of a reassurance light with location light function
- Input/output for the speech communication, microphone and loudspeaker separately
- Output for the request of a speech connection by the nurse call system (serves for switching between different signal sources as telephone, TV sound, nurse call system)
- Mounting on a top-hat rail e.g. in a medical supply unit

Technical data

Dimensions (HxWxD):	13 x 51 x 95 mm (without fixing clips)
Power supply:	24 V DC
Standby current consumption:	26 mA
Weight:	28 g (without fixing clips)

Order no.	Product name	Note
77 0880 00	RAN interface with speech	

Power supply unit 10 A, DIN rail

77 3410 00



General description

Power supply unit for supplying the nurse call system with safety extra-low voltage SELV.

The number of rooms or individual components, that can be connected, is project specific.

2x MOPP acc. to EN 60601-1.

EMC tested acc. to EN 60601-1-2.

Wide range input for international use. Short-circuit and overload protected.

DC ok LED and DC ok relay contact for further fault processing.

Designed for the installation onto a 35 mm DIN rail in an enclosure providing protection against electrical, mechanical and fire hazards. The power supply unit is designed for convection cooling and does not require an external fan.

Technical data

Input

Nominal voltage:	100 – 240 V AC (-15%/+10%)
Input frequency:	50 – 60 Hz ±6%

Output

Nominal current:	10 A
Nominal voltage:	24 V DC
Adjustment range:	24 – 28 V DC
Output power:	240 W

Conformities

Safety:	EN 60601-1:2006+A1:2013
CE marked acc. to:	2014/35/EU, 2014/30/EU, 2014/34/EU, 2011/65/EU
Fulfilled standards:	EN 60601-1; EN 61000-6-1; EN 61000-6-2; EN 61000-6-3; EN 61000-6-4; EN IEC 63000
Testing voltage:	PRI – SEC: 4 kV
Class of protection:	Class I (acc. EN 61140)
Ingress protection code:	IP20

Connections

Input, output:	Quick-connect spring clamp terminals
DC ok signal:	Push-in terminals

Permissible ambient conditions

Ambient temperature:	-25 to +70 °C
Relative humidity:	5 to 95% (non-condensing)
Pollution degree:	2 (No condensation or frost is allowed.)

General

MTBF SN 29500:	661.000 h at 10 A, +40 °C
Weight:	620 g
Dimensions (HxWxD):	124 x 39 x 117 mm

Power supply unit 10 A, DIN rail

77 3410 00

- Page 2 -



Order no.	Product name	Note
77 3410 00	Power supply unit 10A, DIN rail	
Wall mounting cabinets, suitable for the installation of devices of the modular power supply, order if required:		
77 3510 06	10" Wall mounting cabinet, 6U, GD	see appendix "Accessories"
77 3519 07	19" Wall mounting cabinet, 7U, GD	see appendix "Accessories"
77 3519 12	19" Wall mounting cabinet, 12U, GD	see appendix "Accessories"
Equipment support for the installation of devices into wall mounting cabinets, order if required:		
76 0900 01	19" Mounting set	see appendix "Accessories"
76 0900 02	Mounting set for 10" wall mounting cabinet	see appendix "Accessories"

Power supply unit 5 A, DIN rail

77 3410 50



(Image similar)

General description

Power supply unit for supplying the nurse call system with safety extra-low voltage SELV.

The number of rooms or individual components, that can be connected, is project specific.

2x MOPP acc. to EN 60601-1.

EMC tested acc. to EN 60601-1-2.

Wide range input for international use. Short-circuit and overload protected.

DC ok LED and DC ok relay contact for further fault processing.

Designed for the installation onto a 35 mm DIN rail in an enclosure providing protection against electrical, mechanical and fire hazards. The power supply unit is designed for convection cooling and does not require an external fan.

Technical data

Input

Nominal voltage: 100 – 240 V AC (-15%/+10%)
 Input frequency: 50 – 60 Hz ±6%

Output

Nominal current: 5.0 – 4.3A
 Nominal voltage: 24 V DC
 Adjustment range: 24 – 28 V DC

Conformities

Safety: EN 60601-1:2006+A1:2013
 CE marked acc. to: 2014/35/EU, 2014/30/EU, 2014/34/EU, 2011/65/EU

Fulfilled standards: EN 60601-1; EN 61000-6-1; EN 61000-6-2; EN 61000-6-3; EN 61000-6-4; EN IEC 63000

Testing voltage: PRI – SEC: 4 kV
 Class of protection: Class I (acc. to EN 61140)
 Ingress protection code: IP20

Connections

Input, output: Quick-connect spring clamp terminals
 DC ok signal: Push-In-Terminals

Permissible ambient conditions

Ambient temperature: -25 to +60 °C
 Relative humidity: 5 bis 95% (non-condensing)
 Pollution degree: 2 (No condensation or frost is allowed.)

General

MTBF SN 29500: 867.000 h at 5 A, +40 °C
 Weight: 440 g
 Dimensions (HxWxD): 124 x 32 x 102 mm

Power supply unit 5 A, DIN rail

77 3410 50

- Page 2 -



(Image similar)

Order no.	Product name	Note
77 3410 50	Power supply unit 5A, DIN rail	
Wall mounting cabinets, suitable for the installation of devices of the modular power supply, order if required:		
77 3510 06	10" Wall mounting cabinet, 6U, GD	see appendix "Accessories"
77 3519 07	19" Wall mounting cabinet, 7U, GD	see appendix "Accessories"
77 3519 12	19" Wall mounting cabinet, 12U, GD	see appendix "Accessories"
Equipment support for the installation of devices into wall mounting cabinets, order if required:		
76 0900 01	19" Mounting set	see appendix "Accessories"
76 0900 02	Mounting set for 10" wall mounting cabinet	see appendix "Accessories"

UPS Control unit 10A

for power supply units, order no. 77 3410 xx

77 3411 00



General description

UPS control unit used in combination with a 24 V DC power supply unit and an external 12 V battery to bridge power failures. When the power supply voltage fails, the energy stored in the battery is released to the load in a regulated process.

Use with power supply unit 10A, DIN rail (order no. 77 3410 00) and battery module (order no. 77 3412 00) for uninterrupted operation with 60 minutes backup power supply at 80% load.

Use with power supply unit 5A, DIN rail (order no. 77 3410 50) and battery module (order no. 77 3412 00) for uninterrupted operation with 150 minutes backup power supply at 80% load.

Superior battery management for charging and monitoring of the external battery as well as a stable output voltage over the entire period of battery operation.

Comprehensive diagnostic and monitoring functions; "replace battery" signal included.

Short-circuit and overload protected.

Designed for the installation onto a 35 mm DIN rail in an enclosure providing protection against electrical, mechanical and fire hazards. The device is designed for convection cooling and does not require an external fan.

Technical data

Input

Nominal voltage: 24 V DC (-20%/+25%)

Output in mains operation

Output current: nom. 15 A
 Output power: nom. 360 W
 Output voltage: Input voltage minus 230 mV (at 10 A load)

Output in battery operation

Output current: 10 A
 Output voltage: 22.25 V DC (at 10 A load)
 Battery voltage: nom. 12 V DC

Bridging time with power supply unit 10A, DIN rail (77 3410 00) and battery module (77 3412 00):

- at nominal current

10A: typ. 55 minutes

- at 80% load: typ. 60 minutes

Bridging time with power supply unit 5A, DIN rail (77 3410 50) and battery module (77 3412 00):

- at nominal current 5A: typ. 130 minutes

- at 80% load: typ. 150 minutes

Battery charging time: typ. 17 hours

Conformities

CE marked acc. to: 2014/30/EU, 2014/34/EU, 2011/65/EU

Fulfilled standards: EN 61000-6-3; EN 61000-6-4; EN 61000-6-2; EN 61000-6-1; EN 60079-0; EN 60079-7; EN 60079-15; EN IEC 63000

Class of protection: Class III (acc. to EN 61140)

Ingress protection code: IP20

UPS Control unit 10A

for power supply units, order no. 77 3410 xx

77 3411 00



Connections

Input, output, battery: Quick-connect spring clamp terminals

Signal connection: Screw terminals

Permissible ambient conditions

Ambient temperature: -25 to +70 °C

Relative humidity: 5 to 95% (non-condensing)

Pollution degree: 2 (No condensation or frost is allowed)

General

Power reserves: 50%

MTBF SN 29500: 886,000 h at 10 A, +40 °C

Weight: 530 g

Dimensions (HxWxD): 124 x 49 x 117 mm

Order no.	Product name	Note
77 3411 00	UPS Control unit 10A	
Required accessories, order separately:		
76 0900 04	DIN rail raiser HAGER HYA036	see appendix "Accessories". 1 DIN rail raiser required per UPS control unit.

Battery module

for UPS control unit 10A (77 3411 00)

77 3412 00



General description

Module incl. battery, mounting bracket, wiring and fuse, which is used in combination with a 24V DC power supply unit and a UPS control unit 10A (order no. 77 3411 00) to bridge power failures.

Use with power supply unit 10A, DIN rail (order no. 77 3410 00) and UPS control unit 10A (order no. 77 3411 00) for uninterrupted operation with 60 minutes backup power supply at 80% load.

Use with power supply unit 5A, DIN rail (order no. 77 3410 50) and UPS control unit 10A (order no. 77 3411 00) for uninterrupted operation with 150 minutes backup power supply at 80% load.

Long life battery: 10 to 12 years acc. to EUROBAT. In a typical application it is recommended to replace the batteries at least every 5 years.

Low space requirement. Easy access to the terminals and the fuse. Heavy duty fuse holder and spare fuse included

Designed for the installation inside an enclosure providing protection against electrical, mechanical and fire hazards. Ensure sufficient ventilation by following

the requirements of the EN 62485-2.

Technical data

Battery characteristics

Battery type:	VRLA, lead acid
Battery voltage:	12 V DC
Battery capacity:	approx. 26 Ah
Battery current:	max. 30 A for discharging max. 5.5 A for charging
Self-discharge rate:	3% per month at 20 °C
Battery fuse:	30 A (ATOF)

Conformities

CE marked acc. to:	2014/30/EU; 2014/34/EU; 2011/65/EU (excluding battery)
Fulfilled standards:	EN 61000-6-3; EN 61000-6-4; EN 61000-6-2; EN 61000-6-1; EN 60079-0; EN 60079-7; EN 60079-15; EN IEC 63000
Class of protection:	Class III (acc. to EN 61140)
Ingress protection code:	IP00

Permissible ambient conditions

Ambient temperature:	
- for charging:	-10 to +50 °C
- for discharging:	-15 to +60 °C
- for transport and storage:	-20 to +50 °C (performance and lifetime might change for storage at temperatures higher than 25 °C)
Relative humidity:	5 to 95% (non-condensing)
Pollution degree:	2 (No condensation or frost is allowed.)

Allgemein

Dimensions (HxWxD):	179 x 214 x 158 mm
Weight:	10.1 kg (incl. battery)
Connection:	Screw terminals

Order no.	Product name	Note
77 3412 00	Battery module	

DC-UPS with capacitor storage 24V, 6kWs

for power supply units, order no. 77 3410 xx

77 3413 00



General description

DC-UPS with built-in storage capacitors, which is used in combination with a 24V power supply unit to bridge short-term power failures or voltage fluctuations. When the power supply voltage fails, the energy stored in the capacitors is released to the load in a regulated process. Suitable for nurse call systems with a central UPS mains supply.

Use with power supply unit 10A, DIN rail (order no. 77 3410 00) for short-term uninterrupted operation with 16.5 seconds backup supply.

Use with power supply unit 5A, DIN rail (order no. 77 3410 50) for short-term uninterrupted operation with 39 seconds backup supply.

Maintenance-free DC-UPS with electrochemical double layer capacitors (EDLC). Typically >10 years operational lifetime expectancy.

Comprehensive diagnostic and monitoring functions.

Short-circuit and overload protected.

Designed for the installation onto a 35 mm DIN rail in an enclosure providing protection against electrical, mechanical and fire hazards. The device is designed for convection cooling and does not require an external fan.

Technical data

Input

Nominal voltage: 24 V DC (-20%/+25%)

Output in power supply mode

Output current: nom. 15 A

Output power: nom. 360 W

Output voltage: Input voltage minus 230 mV (at 10 A load)

Output in buffer mode

Output current: max. 15 A

Output voltage: 22.25 V DC (at 10 A Last)

Buffer time at nominal current 10A: typ. 16.5 seconds

Buffer time at nominal current 5A: typ. 39 seconds

Charging time, when capacitor is completely discharged: typ. 16 minutes

Charging time after discharging with 5A until buffering stops: typ. 4,5 minutes

Conformities

CE marked acc. to: 2014/30/EU, 2014/34/EU, 2011/65/EU

Fulfilled standards: EN 61000-6-3; EN 61000-6-4; EN 61000-6-2; EN 61000-6-1; EN 60079-0; EN 60079-7; EN 60079-15; EN IEC 63000

Class of protection: Class III (acc. to EN 61140)

Ingress protection code: IP20

Connections

Input, output: quick-connect spring-clamp terminals

Signal connection: pluggable spring-clap terminals

DC-UPS with capacitor storage 24V, 6kWs

for power supply units, order no. 77 3410 xx

77 3413 00

- Page 2 -



Permissible ambient conditions

Ambient temperature: -40 to +60 °C

Relative humidity: 5 to 95% (non-condensing)

Pollution degree: 2 (No condensation or frost is allowed.)

General

Power reserve: 50%

MTBF SN 29500: 899.000 h at 10 A, +40 °C

Weight: 1150 g

Dimensions (HxWxD): 124 x 126 x 117 mm

Order no.	Product name	Note
77 3413 00	DC-UPS with capacitor storage 24V, 6kWs	
Required accessories, order separately:		
76 0900 04	DIN rail raiser HAGER HYA036	see appendix "Accessories". 2 DIN rail raisers required per DC-UPS.

iVi™

for use with radio receiver-T and -T UP

P68005/47



General description

iVi™ is an intelligent personal radio trigger. The iVi™ allows the wearer to press a call button to generate a call manually. An integrated, intelligent fall detection technology automatically generates a call if it detects a fall.

Before the iVi™ triggers an emergency call in the event of a fall, it emits a tone sequence for 10 seconds and the control lamp lights up green (pre-alarm). This allows the user to prevent a fall emergency call by pressing the cancel button.

In conjunction with home units, the iVi™ can report to the emergency call recipient if the iVi™ has not been worn for several days. In addition, the emergency call receiver of home units can be informed if the user has cancelled fall emergency calls with the cancel button on iVi™.

Specification

- Use with the following Tunstall products:
 - All current home units
 - All radio receivers-T and -T UP
 - CareAssist
- Call button for manually raising a call
- Automatically generating a call if a fall is detected
- Pre-alarm allows the user to cancel a fall emergency call with the cancel button.
- Cancel button can be deactivated by programming
- Dust tight and protected against ingress of water when iVi™ is immersed in water under defined conditions of pressure and time (IP67)
- Transport mode for storage and transport saves battery capacity
- Adjustable sensitivity for falls
- Emergency call if iVi™ has not been worn for several days (adjustable: 3, 5, 7 days) (with home units)
- Lithium battery (CR2450, 3 V) in easy-open compartment to enable simple replacement. Battery life: approx. 9 to 12 months. On delivery of the iVi™ the battery is already installed, but deactivated.
- Automatic battery monitoring and control LED
- Signalling when the battery of the iVi™ is low:
 - The home unit automatically triggers a background call to the monitoring centre.
 - The LED on the radio receiver-T or -T UP flashes red.
 - The CareAssist alerts the user with a transmitter battery low message
- Auto presence monitoring
- Radio range depending on the building structure:
 - to home unit: up to 50 m
 - to radio receiver-T or -T UP: up to 30 m
 - to CareAssist: up to 50 m
- Accessories: brooch clip, neckcord, belt clip

iVi™

for use with radio receiver-T and -T UP

P68005/47

- Page 2 -



Technical data

- Dimensions (HxWxD): 58 x 38 x 14 mm
- Weight iVi™: 25 g
- Weight iVi™ + brooch clip + neckcord: 30 g
- Radio frequency: 869.2125 MHz
- Ambient temperature
 - Operation: 0 °C to 45 °C
 - Storage: -10 °C to 50 °C
- Relative humidity (non-condensing)
 - Operation: 0% to 80%
 - Storage: 0% to 93%

Order no.	Product name	Note
P68005/47	iVi™	
Use with radio receiver:		
Z 00 8202 33	Radio receiver-T	for connection socket 700xxxxx
Z 00 8202 35	Radio receiver-T UP	
Spare parts, order if required:		
D6602026	Belt clip iVi™	Packing unit 10 pieces
D6602027	Brooch clip iVi™	Packing unit 10 pieces
D6602044	Neckcord iVi™	Packing unit 10 pieces
D6602034	Cover for battery compartment iVi™	Packing unit 1 piece

MyAmie

for use with radio receiver-T and -T UP

P68007/02



General description

A small and waterproof personal radio trigger for wireless initiation of calls. It is light weight and provides different wearing options. A wrist strap and a neckcord are included with scope of delivery.

Specification

- Use with the following Tunstall products:
 - All current home units
 - All radio receivers-T and -T UP
 - CareAssist
- Call button
- Control LED lights up red, if call button is pressed
- Neckcord
- Wrist strap, 20 mm wide
- Auto presence monitoring

- Radio range depending on the building structure:
 - to home unit: up to 50 m
 - to radio receiver-T or -T UP: up to 30 m
 - to CareAssist: up to 50 m
- Control LED and automatic battery monitoring
- Signalling when the battery of MyAmie is low:
 - The home unit automatically triggers a background call to the monitoring centre.
 - The LED on the radio receiver-T or -T UP flashes red.
 - The CareAssist alerts the user with a transmitter battery low message.
- Dust tight and protected against ingress of water when MyAmie is immersed in water under defined conditions of pressure and time (IP67)
- Long-lasting material durability due to the high performance plastic Hytrel®
- Lithium-Battery
- Prognosticated battery life: 7 years

Technical data

Dimensions (HxWxD):	14 x 27 x 36 mm
Weight:	7 g
Housing material:	ABS
Call button material:	Hytrel®
Radio frequency:	869.2125 MHz
Ambient temperature:	
- Operation:	0 °C to 45 °C
- Storage:	-10 °C to 50 °C

Order no.	Model no. (= Number on the MyAmie label)	Product name	Note
P68007/02	68005/02	MyAmie	Housing: cream white, call button: red
Use with radio receiver:			
Z 00 8202 33		Radio receiver-T	for connection socket 700xxxxx
Z 00 8202 35		Radio receiver-T UP	
Spare parts, order if required:			
D6702137		Neckcord MyAmie, white	Packing unit 10 pieces
D6702145		Wrist strap (20 mm) MyAmie	Packing unit 10 pieces

Wireless sensor mat 869 MHz

for use with radio receiver-T and -T UP

Z 00 8002 01



General description

Large mat for triggering of calls by stepping on or pressing the mat.

Suitable for use in hospitals, care homes or similar establishments.

The mat is positioned e.g. by the bed. A call is raised when the patient gets out of bed or falls out of bed and onto the mat. The call is transmitted to the assigned radio receiver.

Specification

- Use with the following Tunstall products:
 - All current home units
 - All radio receivers-T and -T UP
 - CareAssist
- Large sensor area
- Splash-proof
- Soft PVC, easy to clean
- Radio range depending on the building structure:
 - to home unit: up to 50 m
 - to radio receiver-T or -T UP: up to 30 m
 - to CareAssist: up to 50 m
- Battery operation - no wiring, CR2032, exchangeable
- Signalling when the battery is low:
 - The home unit automatically triggers a background call to the monitoring centre.
 - The LED on the radio receiver-T or -T UP flashes red.
 - The CareAssist alerts the user with a transmitter battery low message.

Technical data

Colour:	ivory-coloured
Material:	Soft PVC
Dimensions (WxD):	1200 x 500 mm
Stepping area thickness:	4 mm
Radio frequency:	869.2125 MHz

Order no.	Product name	Note
Z 00 8002 01	Wireless sensor mat 869 MHz	
Use with radio receiver:		
Z 00 8202 33	Radio receiver-T	for connection socket 700xxxxx
Z 00 8202 35	Radio receiver-T UP	

Sensor mat

for connection socket 700xxxxx

Z 00 8002 02



General description

Large mat for triggering of calls by stepping on or pressing the mat.

Suitable for use in hospitals, care homes or similar establishments.

The mat is positioned e.g. by the bed. A call is raised when the patient gets out of bed or falls out of bed and onto the mat.

Plug-in connection to a connection socket, order no. 70 00xx xx, socket for pear push switch.

Specification

- Large sensor area
- Disconnection monitoring
- Splash-proof
- Soft PVC, easy to clean
- Approx. 4 m flexible cable with plug for connection to a connection socket of the nurse call system, socket for pear push switch

Technical data

Dimensions (WxD): 1200 x 500 mm
 Power supply: 24 V DC
 Standby current consumption: 10 mA
 Colour: ivory-coloured
 Material: Soft PVC
 Stepping area thickness: 4 mm

Order no.	Product name	Note
Z 00 8002 02	Sensor mat	for connection socket 700xxxxx

Wireless step-on sensor mat

for use with radio receiver-T and -T UP

Z 00 8003 0x



Z 00 8003 01



Z 00 8003 02

Specification

- Use with the following Tunstall products:
 - All radio receivers-T and -T UP
 - All current home units
 - CareAssist
- Radio range depending on the building structure:
 - to home unit: up to 50 m
 - to radio receiver-T or -T UP: up to 30 m
 - to CareAssist: up to 50 m
- Large sensor area
- Splash-proof
- Can be damp cleaned and disinfected
- Battery operation - no wiring, CR2032, exchangeable
- Signalling when the battery is low:
 - The home unit automatically triggers a background call to the monitoring centre.
 - The LED on the radio receiver-T or -T UP flashes red.
 - The CareAssist alerts the user with a transmitter battery low message.

General description

Robust, professional contact step-on sensor mat for the monitoring of person movements, also for dementia or vital detection. Sturdy, step-, slip- and stumble-proof design with bevelled edges and easy to clean surface in nap structure.

The mat is positioned e.g. by the bed. A call is raised when the patient gets out of bed or falls out of bed and onto the mat. The call is forwarded to the assigned radio receiver.

Technical data

Colour:	Grey
Ingress protection code:	IP54
Material:	Polyurethane (PU)
Power supply:	3.0 V DC
Dimensions (H x B x T):	9* x 1100 x 700 mm
* Height at the transmitter module:	15 mm
Weight:	approx. 7500 g
Radio frequency:	869.2125 MHz

Order no.	Product name	Note
Z 00 8003 01	Wireless step-on sensor mat CM	rectangular shape
Z 00 8003 02	Wireless step-on sensor mat NM	semicircular shape
Use with radio receiver:		
Z 00 8202 33	Radio receiver-T	for connection socket 700xxxxx
Z 00 8202 35	Radio receiver-T UP	

Large-surface pneumatic switch

for connection socket 700xxxxx

Z 00 8201 13



General description

Large-surface pneumatic switch for call activation. Only a very slight actuation force is required in order to activate the switch. It is therefore very well suited when there are activation problems due to illness.

Plug-in connection to a connection socket, order no. 70 0xxx xx, socket for pear push switch.

Specification

- Red call button, round
- Optical reassurance indicator that lights up all around as well as vibration when the button is pressed (vibration function can be disabled)
- Disconnection monitoring
- Ingress protection code: IP44 (Do not use in wet cells)
- Approx. 2 m flexible cable with plug for connection to a connection socket of the nurse call system, socket for pear push switch

Technical data

Dimensions (HxØ):	40 x 110 mm
Power supply:	24 V DC
Standby current consumption:	16 mA
Colour:	rot
Weight:	approx. 300 g
Ø pressure surface:	90 mm
Bellows material:	TPE/TPR
Ambient temperature:	-10 °C to +55 °C

Order no.	Product name	Note
Z 00 8201 13	Large-surface pneumatic switch	
Optional accessories, order if required		
Z 00 8201 16	Wall bracket	for screw fixing

Large-surface radio pneumatic switch

for use with radio receiver-T and -T UP

Z 00 8201 15



General description

Wireless large-surface pneumatic switch. Only a very slight actuation force is required in order to activate the switch. It is therefore very well suited when there are activation problems due to illness.

Specification

- Use with the following Tunstall products:
 - All current home units
 - All radio receivers-T and -T UP
 - CareAssist
- Red triggering surface, round
- Optical reassurance indicator that lights up all around as well as vibration when the button is pressed (vibration function can be disabled)
- Radio range depending on the building structure:
 - to home unit: up to 50 m
 - to radio receiver-T or -T UP: up to 30 m
 - to CareAssist: up to 50 m
- Signalling when the battery is low:
 - The home unit automatically triggers a background call to the monitoring centre.
 - The LED on the radio receiver-T or -T UP flashes red.
 - The CareAssist alerts the user with a transmitter battery low message.
- Ingress protection code: IP44 (Do not use in wet cells)
- 3 V Battery (CR2450), replaceable

Technical data

Colour: rot
 Dimensions (HxB): 40 x 110 mm
 Weight: 200 g
 Triggering surface diameter: 90 mm
 Bellows material: TPE/TPR
 Radio frequency: 869.2125 MHz
 Ambient temperature: -10 °C to +55 °C

Order no.	Product name	Note
Z 00 8201 15	Large-surface radio pneumatic switch	
Use with radio receiver:		
Z 00 8202 33	Radio receiver-T	for connection socket 700xxxxx
Z 00 8202 35	Radio receiver-T UP	
Optional accessories, order if required		
Z 00 8201 16	Wall bracket	for screw fixing

Breathing sensor set

for connection socket 700xxxxx

Z 00 8201 40



Specification

- Sensor unit for call initiation via breathing or blowing noises incl. approx. 2 m flexible connection cable and plug for connection to a socket of the nurse call system, socket for pear push switch
- Universal clamp bracket with 60 cm flexible goose-neck
- Integrated status display on the sensor head
- Control module with status displays and further setting options
- Disconnection monitoring

Technical data

Dimensions of sensor unit

(HxWxD):	80 x 130 x 30 mm
Power supply:	24 V DC
Standby current consumption:	200 mA
Settings:	ambient sound, brightness, location light
Status indication:	Operation, call, blocking
Fixing:	Clamp bracket
Ingress protection code:	IP30
Weight:	approx. 950 g

General description

Contact-less call sensor for call initiation by breath. The breathing sensor enables persons with very severe motor impairments to trigger calls by means of breath / blowing sounds. Even the slightest breathing triggers a call.

Inadvertent triggering, e.g. by ambient noise, is largely suppressed by an intelligent sound evaluation system.

Integrated operating displays show the current device status.

Plug-in connection to a connection socket, order no. 70 0xxx xx, socket for pear push switch.

Order no.	Product name	Note
Z 00 8201 40	Breathing sensor set	for connection socket 700xxxxx

Radio receiver-T

for connection socket 700xxxxx

Z 00 8202 33



General description

Radio receiver on operating frequency 869.2125 MHz (social alarm frequency) for receiving the signals from assigned radio transmitters.

Plug-in connection to a connection socket, order no. 70 0xxx xx, socket for pear push switch. Activating the radio trigger generates the same call type that would be generated by a pear push switch connected to the same socket.

Note: The radio transmission is not monitored. According to the German standard DIN VDE 0834 the transmitters may be used only as complementary call devices in combination with a nurse call system.

Specification

- Integrated antenna
- 64 radio transmitters programmable
- Master mode can be activated to receive any number of radio transmitters
- If the battery of the assigned radio trigger is low, the LED on the radio receiver is flashing red
- In the event of reception blockage, fault indication on the radio receiver and call initiation
- Care mode available, deactivates selected transmitters for a set time at the touch of a key
- Daily message monitoring available with MyAmie, iVi™ and universal sensor, corresponds to the auto presence feature of Telecare devices
- Vital monitoring available e.g. with wireless sensor mat, corresponds to inactivity monitoring of Telecare devices
- Disconnection monitoring
- Ingress protection code: IP20
- Radio range dependent on the spatial conditions, up to 30 m
- Short connection cable (approx. 16 cm) with plug

Usable radio transmitters

- MyAmie (order no. P68007/02)
- iVi™ (order no. P68005/47)
- Universal sensor (order no. 61005/30)
- Large-surface pneumatic radio switch (order no. Z00820215)
- Wireless sensor mat (order no. Z00800201)
- Wireless step-on sensor mat CM (order no. Z00800301)
- Wireless step-on sensor mat NM (order no. Z00800302)
- Optical 869 Smoke Alarm (order no. 68005/70)
- Heat Alarm 869 (order no. 68005/71)
- Further radio transmitters on request

Radio receiver-T

for connection socket 700xxxxx

Z 00 8202 33



Technical data

Dimensions (HxWxD):	66 x 46 x 18 mm
Power supply:	24 V DC
Standby current consumption:	12 mA
Weight:	approx. 50 g

Order no.	Product name	Note
Z 00 8202 33	Radio receiver-T	for connection socket 700xxxxx
Optional accessories, order if required		
Z 00 8202 21	Magnetic wall bracket	see appendix "Accessories"

Radio receiver-T UP

with free wire ends

Z 00 8202 35



- If the battery of the assigned radio trigger is low, the LED on the radio receiver is flashing red
- In the event of reception blockage, fault indication on the radio receiver and call initiation
- Care mode available, deactivates selected transmitters for a set time at the touch of a key
- Daily message monitoring available with MyAmie, iVi™ and universal sensor, corresponds to the auto presence feature of Telecare devices
- Vital monitoring available e.g. with wireless sensor mat, corresponds to inactivity monitoring of Telecare devices
- Radio range depending on the building structure, up to 30 m
- Support ring included in scope of supply
- Frame with 55 mm internal dimension required, not included in scope of delivery.
- Connection to a RAN interface or to a CONCENTO^{PLUS} room controller without RAN

General description

Radio receiver on operating frequency 869.2125 MHz (social alarm frequency) for receiving the signals from assigned radio transmitters

The radio receiver-T UP is intended for the connection to a room terminal in the following systems: Flamenco^{IP+}, Flamenco^{IP}, Flamenco, CONCENTO^{CARE}, CONCENTO^{PLUS}.

Triggering the radio transmitters triggers a call or radio call, depending on the nurse call system and its configuration

Note: The radio transmission is not monitored. According to the German standard DIN VDE 0834 the transmitters may be used only as complementary call devices in combination with a nurse call system.

Specification

- Flush mounting on 1-gang back box
- Potential-free connection as normally closed or normally open contact
- Integrated antenna
- 64 radio transmitters programmable
- Master mode can be activated to receive any number of radio transmitters

Usable radio transmitters

- MyAmie (order no. P68007/02)
- iVi™ (order no. P68005/47)
- Universal sensor (order no. 61005/30)
- Large-surface pneumatic radio switch (order no. Z00820215)
- Wireless sensor mat (order no. Z00800201)
- Wireless step-on sensor mat CM (order no. Z00800301)
- Wireless step-on sensor mat NM (order no. Z00800302)
- Optical 869 Smoke Alarm (order no. 68005/70)
- Heat Alarm 869 (order no. 68005/71)
- Further radio transmitters on request

Radio receiver-T UP

with free wire ends

Z 00 8202 35

- Page 2 -

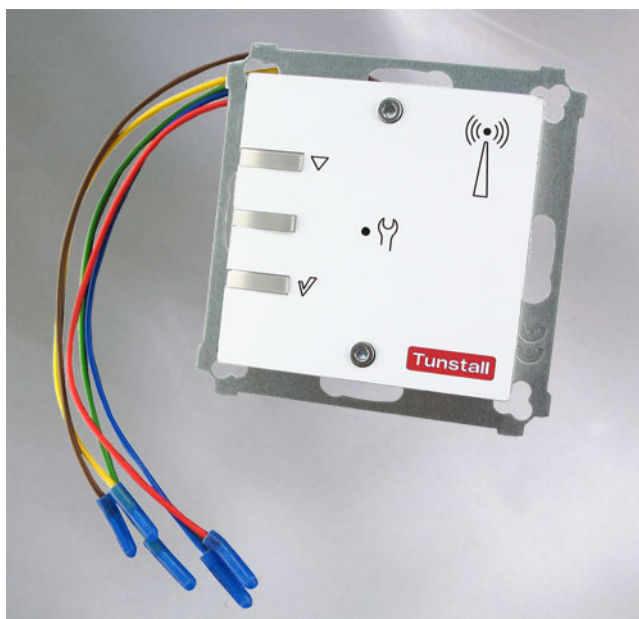

Technical data

Dimensions (HxWxD):	55 x 55 x 10 mm
Power supply:	24 V DC
Standby current consumption:	12 mA
Weight:	approx. 50 g

Order no.	Product name	Note
Z 00 8202 35	Radio receiver-T UP	
Order frame separately:		
77 0210 53 + 77 0210 56	Frame + intermediate frame future linear	
Necessary accessories, order separately:		
17 0100 00	Back box solid wall, 1-gang	see appendix "Accessories"
17 5100 00	Back box partition wall, 1-gang	see appendix "Accessories"
77 0840 00	RAN-Interface	see appropriate data sheet

Appendix: Services

Services	Order no.
<p data-bbox="165 367 852 405">Software support Function module UM/UMS</p> <p data-bbox="165 412 564 450"><i>repeating per installed module</i></p> <p data-bbox="165 472 1241 539">Software support serves to maintain operational and data security in the long term and to update the functionality of the software module mentioned.</p> <p data-bbox="165 562 376 595">Scope of services</p> <ul data-bbox="165 600 999 857" style="list-style-type: none"> • Irregular updates according to release plan, usually 2 times a year • Ensuring system integrity • Minor adaptations/improvements • Security patches • Executing the services during normal Tunstall business hours • Updates during ongoing operation <p data-bbox="165 880 328 913">Prerequisites</p> <ul data-bbox="165 918 1262 1070" style="list-style-type: none"> • Conclusion of a software support contract • A remote connection to the nurse call system is required for performing updates • Release of the remote access at the latest when Tunstall announces the implementation of the update <p data-bbox="165 1093 252 1126">Option</p> <p data-bbox="165 1131 1262 1198">If remote access is not available, software support can also be carried out directly on site. In this case, the usual costs for a service visit will be charged additionally.</p> <p data-bbox="165 1220 233 1254">Costs</p> <p data-bbox="165 1258 1262 1326">The price is an annual fee. The general terms and conditions of business and licensing for the permanent software use of 04 March 2020 apply.</p>	<p data-bbox="1295 367 1436 400">76 7040 00</p>

Services	Order no.
<p data-bbox="165 367 849 405">Software support Function module MED/FAS</p> <p data-bbox="165 412 564 450"><i>repeating per installed module</i></p> <p data-bbox="165 472 1238 539">Software support serves to maintain operational and data security in the long term and to update the functionality of the software module mentioned.</p> <p data-bbox="165 562 376 595">Scope of services</p> <ul data-bbox="165 600 999 857" style="list-style-type: none"> • Irregular updates according to release plan, usually 2 times a year • Ensuring system integrity • Minor adaptations/improvements • Security patches • Executing the services during normal Tunstall business hours • Updates during ongoing operation <p data-bbox="165 880 328 913">Prerequisites</p> <ul data-bbox="165 918 1262 1070" style="list-style-type: none"> • Conclusion of a software support contract • A remote connection to the nurse call system is required for performing updates • Release of the remote access at the latest when Tunstall announces the implementation of the update <p data-bbox="165 1093 252 1126">Option</p> <p data-bbox="165 1131 1262 1198">If remote access is not available, software support can also be carried out directly on site. In this case, the usual costs for a service visit will be charged additionally.</p> <p data-bbox="165 1220 233 1254">Costs</p> <p data-bbox="165 1258 1262 1326">The price is an annual fee. The general terms and conditions of business and licensing for the permanent software use of 04 March 2020 apply.</p>	<p data-bbox="1300 367 1437 400">76 7041 00</p>





Services	Order no.
<p data-bbox="164 367 868 405">Software support Function module VOIP GATE</p> <p data-bbox="164 412 564 450"><i>repeating per installed module</i></p> <p data-bbox="164 472 1238 539">Software support serves to maintain operational and data security in the long term and to update the functionality of the software module mentioned.</p> <p data-bbox="164 562 376 595">Scope of services</p> <ul data-bbox="164 600 999 857" style="list-style-type: none"> • Irregular updates according to release plan, usually 2 times a year • Ensuring system integrity • Minor adaptations/improvements • Security patches • Executing the services during normal Tunstall business hours • Updates during ongoing operation <p data-bbox="164 880 328 913">Prerequisites</p> <ul data-bbox="164 918 1262 1070" style="list-style-type: none"> • Conclusion of a software support contract • A remote connection to the nurse call system is required for performing updates • Release of the remote access at the latest when Tunstall announces the implementation of the update <p data-bbox="164 1093 253 1126">Option</p> <p data-bbox="164 1131 1262 1198">If remote access is not available, software support can also be carried out directly on site. In this case, the usual costs for a service visit will be charged additionally.</p> <p data-bbox="164 1220 233 1254">Costs</p> <p data-bbox="164 1258 1262 1326">The price is an annual fee. The general terms and conditions of business and licensing for the permanent software use of 04 March 2020 apply.</p>	<p data-bbox="1299 367 1436 400">76 7042 00</p>





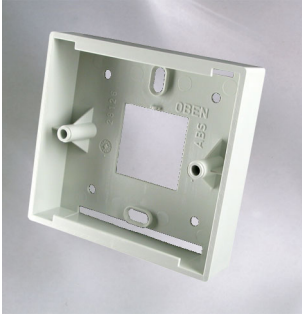

Services	Order no.
<p data-bbox="165 367 799 405">Software support System module HEALTH</p> <p data-bbox="165 412 564 450"><i>repeating per installed module</i></p> <p data-bbox="165 472 1238 539">Software support serves to maintain operational and data security in the long term and to update the functionality of the software module mentioned.</p> <p data-bbox="165 562 376 595">Scope of services</p> <ul data-bbox="165 600 999 857" style="list-style-type: none"> • Irregular updates according to release plan, usually 2 times a year • Ensuring system integrity • Minor adaptations/improvements • Security patches • Executing the services during normal Tunstall business hours • Updates during ongoing operation <p data-bbox="165 880 328 913">Prerequisites</p> <ul data-bbox="165 918 1262 1070" style="list-style-type: none"> • Conclusion of a software support contract • A remote connection to the nurse call system is required for performing updates • Release of the remote access at the latest when Tunstall announces the implementation of the update <p data-bbox="165 1093 252 1126">Option</p> <p data-bbox="165 1131 1262 1198">If remote access is not available, software support can also be carried out directly on site. In this case, the usual costs for a service visit will be charged additionally.</p> <p data-bbox="165 1220 233 1254">Costs</p> <p data-bbox="165 1258 1262 1326">The price is an annual fee. The general terms and conditions of business and licensing for the permanent software use of 04 March 2020 apply.</p>	<p data-bbox="1302 367 1437 400">76 7130 00</p>



Services	Order no.
<p>Software support System module CARE <i>repeating per installed module</i></p> <p>Software support serves to maintain operational and data security in the long term and to update the functionality of the software module mentioned.</p> <p>Scope of services</p> <ul style="list-style-type: none"> • Irregular updates according to release plan, usually 2 times a year • Ensuring system integrity • Minor adaptations/improvements • Security patches • Executing the services during normal Tunstall business hours • Updates during ongoing operation <p>Prerequisites</p> <ul style="list-style-type: none"> • Conclusion of a software support contract • A remote connection to the nurse call system is required for performing updates • Release of the remote access at the latest when Tunstall announces the implementation of the update <p>Option</p> <p>If remote access is not available, software support can also be carried out directly on site. In this case, the usual costs for a service visit will be charged additionally.</p> <p>Costs</p> <p>The price is an annual fee. The general terms and conditions of business and licensing for the permanent software use of 04 March 2020 apply.</p>	76 7135 00
<p>PrimusGlobal+ System set-up & configuration</p> <p>The PrimusGlobal+ software family effectively complements the Flamenco nurse call system. Basic installation work for operating the system and installation/preparation of the relevant function modules, components, and drivers.</p> <p>Hardware is prepared and tested according to the specific requirements.</p> <p>The hierarchic structure for the user screen surface is established according to the requirements.</p> <p>Scope of services:</p> <ul style="list-style-type: none"> • Installation of the operating system • Installation of functional units, modules and drivers • Preparation of hardware and functional checks • Set-up of operating structure and surface • Various function checks and documentation of the configuration 	77 0790 00



Services	Order no.
<p>PrimusGlobal+ Project data, block graphics <i>Maximum 36 rooms</i></p> <p>Additionally to the system set-up & configuration the single rooms have to be configured according to the project specific requirements. The project specific data and designations for buildings, wards and rooms are established. The individual display elements for rooms and wards are placed and activated in the desired way. Presentation as standard graphic elements.</p> <ul style="list-style-type: none"> • Entering project specific data • Using block graphics 	77 0790 01
<p>PrimusGlobal+ Project data, layout graphics <i>Maximum 36 rooms</i></p> <p>Additionally to the system set-up & configuration the single rooms have to be configured according to the project specific requirements. The project specific data and designations for buildings, wards and rooms are established. The individual display elements for rooms and wards are placed and activated in the desired way. Presentation in compliance with the plan view.</p> <ul style="list-style-type: none"> • Entering project specific data • Importing CAD data for usage as plan view • Adaptation of the delivered plan views for preparing them as display levels <p>The plan views have to be delivered by the customer as CAD files.</p>	77 0790 02



Appendix: Accessories



Specification	Order no.	
<p>Connector, 5-pole <i>e.g. for connection socket with call switch</i></p> <p>Plug-in screw clamp e.g. for the connection of connection socket with call switch (70 0171 60...), connection socket with call switch, bedhead unit (70 0171 50) or for the use of the RS232 port of the IP-SystemManager.</p> <ul style="list-style-type: none"> • Screw connections up to 1.5 mm² • Distort protection <p><i>Dimensions (HxWxD): 10 x 20 x 19 mm</i></p>	00 0211 37	
<p>ESD protection cover “short” <i>e.g. for OSYlink-Group lamp, as protection when the unit is not installed in a switch cabinet.</i></p> <ul style="list-style-type: none"> • Material: plastic, transparent • Velcro fixing strips <p><i>Weight: 15 g</i> <i>Dimensions (HxWxD): 155 x 125 x 50 mm</i></p>	00 0276 53	
<p>ESD protection cover “long” <i>e.g. for OSYlink-Universal, OSYlink-AS, as protection when the unit is not installed in a switch cabinet.</i></p> <ul style="list-style-type: none"> • Material: plastic, transparent • Velcro fixing strips <p><i>Weight: 21 g</i> <i>Dimensions (HxWxD): 155 x 180 x 50 mm</i></p>	00 0276 54	
<p>Surface mounting frame <i>for room signal lamps</i></p> <ul style="list-style-type: none"> • Material: ABS <p><i>Dimensions (HxWxD): 80 x 86 x 21 mm</i></p>	00 0281 26	
<p>Terminating resistor 120 Ohm</p> <p>as bus termination in the last bus user of the group bus OSYnet.</p>	00 0040 76	

Specification	Order no.	
<p>Back box solid wall, 1-gang <i>Installation opening: Ø 60 mm</i></p> <p>Depth: 46 mm</p>	17 0100 00	
<p>Back box solid wall, 2-gang <i>Installation opening: 140 x 60 x 42 mm, oval</i></p> <p>Without divider</p>	17 0410 00	
<p>Back box partition wall, 1-gang <i>Burr hole: Ø 68 mm</i></p> <p>Depth: 47 mm</p>	17 5100 00	
<p>Back box partition wall, 2-gang <i>Burr hole: Ø 2 x 68 mm, oval</i></p> <p>Depth: 47 mm, centre distance: 71 mm, without divider</p>	17 5400 00	
<p>Extension set for ceiling suspension, 0.5 m <i>for corridor displays 19078416, 29078412, 76016000</i></p> <p>For extending the ceiling suspension by 50 cm.</p> <ul style="list-style-type: none"> • 2 wire rope connectors, with wire rope holder on both sides for rope diameter 1.0 up to 1.5 mm • 2 extension ropes, 50 cm 	19 0780 05	
<p>Button cap, white, call button <i>for connection socket with call switch</i></p> <p>White button cap with red call symbol in exchange to the red button cap with white call symbol, when installing a connection socket with call switch, order no. 70017150 or 70017160..., into a medical supply unit.</p> <p><i>Dimensions (HxWxD): 15 x 15 x 9.7 mm</i></p>	19 9102 40	

Specification	Order no.	
<p>Connection cable</p> <p>e.g. for the connection of a call device to the additional external call input of a connection socket with call switch or connection socket with call switch, bedhead unit.</p> <ul style="list-style-type: none"> Length: approx. 50 cm 	50 0308 02	
<p>Equipment and cable clamp</p> <p>Protection for all plug connected patient equipment against pulling force. Cables and equipment are safely guided along the bed supporting rod or the “bed gallows”.</p> <p>No damage due to patients trying to use the sophisticated equipment as an aid for pulling themselves up. Under excessive pulling force the clamp will slip off the supporting rod.</p> <ul style="list-style-type: none"> Various means for securing different diameters of cables Suitable for use with cables or hoses of 4, 5, 6 and 9 mm diameter (z.B. pear push switch, ePat[®]lite, patient handset) 2 equipment and cable clamps can be put together for doubling the retention force Can also be used for other hospital equipment <p><i>Max. height: 160 mm, max. thickness: 18 mm, width: 70 mm</i> <i>Weight: 23 g</i> <i>Colour: RAL 7035 light grey</i> <i>Material: ABS</i></p>	70 0361 00	
<p>Headphone</p> <p>Dynamic headphone to listen discretely to entertainment/TV programmes in connection with an ePat[®]lite or a patient handset.</p> <ul style="list-style-type: none"> Jack connector 3.5 mm 2 earpieces with support Total impedance: 16 Ohm Approx. 1.8 m connection cable 	70 0801 00	



Specification	Order no.	
<p>Connector, 3-pole</p> <p>Plug-in screw clamp for connection of room bus (RAN) for the switches and the room lamps with RAN connection.</p> <ul style="list-style-type: none"> • Labelled connections • Screw connections up to 1.5 mm² • Distort protection <p><i>Dimensions (HxWxD): 10 x 11 x 15 mm</i></p>	70 0807 00	
<p>Diagnostic connection cable <i>for connection socket 700xxxxx</i></p> <p>Connection cable for connecting a medical electrical device to the nurse call system via a connection socket, order no. 70 0xxx xx, in order to trigger a diagnostic call in the nurse call system for alarms of the medical electrical equipment.</p> <p>Warning! The transmission of the alarms of medical electrical equipment (e.g. monitoring devices) to the nurse call system serves only as supporting, additional information. This is a distributed information system. Due diligence for the operation of such medical electrical equipment remains unaffected in case of the connection to the nurse call system.</p> <ul style="list-style-type: none"> • Free wire ends for the connection of a medical electrical device • Plug for plug-in connection to a connection socket, socket for pear push switch • Length: Approx. 2 m 	70 0812 10	

Specification	Order no.	
<p>RAN interface universal</p> <p>Interface for the connection of external actuators being controlled by an Pat^{®lite} or a patient handset, e.g. lowering/raising the blinds. Transferring the signals in combination with a connection socket combi (order no. 70 0425 00, 70 0424 00) or a connection socket combi, bedhead unit (order no. 70 0435 00, 70 0434 00).</p> <ul style="list-style-type: none"> • 2 potential-free normally open contacts • Maximum contact load: 60 mA / 24 V. • Control by one or all ePat^{®lite} units or patient handsets in the room. • Standby current consumption: 12 mA • Connection to the room bus (RAN). • Intended for mounting on a 35 mm support rail <p><i>Dimensions (HxWxD): 76 x 72 x 41 mm</i></p>	<p>70 0848 00</p>	
<p>Self-releasing adapter patient handset</p> <p>Safety item for connection to a patient handset or an ePat^{®lite}. Consisting of plug and socket for connection to connection sockets, order no. 70 04xx 00.</p> <p>When subjected to a pulling force, the self-releasing adapter automatically separates the connection and protects the connection socket, the cable and the connected device.</p> <ul style="list-style-type: none"> • Ergonomically shaped adapter for connection to connection socket • Flexible design, automatic alignment when pulling force is applied • Connection released when pulled from any direction, up to 90 degrees • 13-pole connector <p><i>Dimensions (HxWxD): 17 x 17 x 120 mm</i> <i>Weight: 52 g</i> <i>Colour: RAL 9002 grey white</i></p>	<p>74 0812 50</p>	

Specification	Order no.	
<p>Self-releasing adapter pear push switch</p> <p>Safety item for connection to a pear push switch. Consisting of plug and socket for connection to connection sockets, order no 70 xxxx xx and 73 xxxx xx.</p> <p>When subjected to a pulling force, the self-releasing adapter automatically separates the connection and protects the connection socket, the cable and the connected device.</p> <ul style="list-style-type: none"> • Ergonomically shaped adapter for connection to connection socket • Flexible design, automatic alignment when pulling force is applied • Connection released when pulled from any direction, up to 90 degrees • 8-pole connector <p><i>Dimensions (HxWxD): 14 x 14 x 120 mm</i> <i>Weight: 26 g</i> <i>Colour: RAL 9002 grey white</i></p>	74 0812 51A	
<p>TV installation kit <i>for hospital LED TV, professional</i></p> <p>1 piece required per project if hospital LED TVs, professional are used.</p>	74 7002 56/ 15	
<p>TV wall mount “Base”</p> <ul style="list-style-type: none"> • One pivot point • Inclinable, rotatable • Vesa MIS-D, 100, MIS-D, 75 • Additional adapters for VESA MIS-E 200x200mm 	74 7002 80	
<p>TV wall mount “Advance”</p> <ul style="list-style-type: none"> • Two pivot points • Inclinable, rotatable and expandable • Vesa MIS-D, 100, MIS-D, 75 • Additional rails for VESA MIS-E 200x200mm 	74 7002 81	

Specification	Order no.	
<p>TV wall mount “Comfort”</p> <ul style="list-style-type: none"> • Three pivot points • Inclinable, rotatable and expandable • Vesa MIS-D, 100, MIS-D, 75 • Additional rails for VESA MIS-E 200x200mm 	<p>74 7002 82</p>	
<p>Hospital LED TV, professional Energy-efficient LED TV for professional use with many comfort features - compact, flat and elegant. Ideally suited for patient rooms. Prepared for use together with Flamenco nurse call system.</p> <p>Picture / Display</p> <ul style="list-style-type: none"> • Display: LED Full HD or HD (depending on the model) • Panel resolution: 1920 x 1080p or 1366 x 768p (depending on the model) • Aspect ratio: 16:9 <p>Tuner/Reception/Transmission</p> <ul style="list-style-type: none"> • Aerial Input: IEC75 • Digital TV: DVB-T/T2/C <p>Connectivity</p> <ul style="list-style-type: none"> • HDMI 1.4 • USB 2.0 • SCART • Digital audio out: Optical • Mains power: 220 – 240 V, 50/60 Hz <p>Philips Medical Card External (PMC-E) For preparing the TV set for control using nurse call system patient units.</p> <ul style="list-style-type: none"> • Set-back-solution incl. external box for mounting to the TV back side for connection of the TV set to the nurse call system. • Specific transformer ST5499 <p>PMC-E cable kit Philips Premium Suite Cable kit for connecting the PMC-E to the TV set.</p> <ul style="list-style-type: none"> • Audio cable: approx. 0.5 m • Data cable: approx. 0.5 m • 12 V power supply incl. approx. 0.5 m cable • Fixing material <p><i>Continuation...</i></p>		

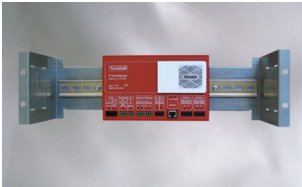
Specification	Order no.	
<p>Hospital LED TV, professional <i>... Continuation</i></p> <p>Control cable PMC-(E) Tunstall Control cable (approx. 1.5 m) for the connection of the TV set to the nurse call system.</p> <ul style="list-style-type: none"> • SCART plug > RJ45 plug <p>Installation service Pre-configuration of the whole system consisting of TV set and PMC-E for use with nurse call system of the Flamenco family.</p> <p><i>As the TV sets are subject of continuous development, please enquire the current specification directly from us.</i></p> <p>Necessary accessories, order separately:</p> <ul style="list-style-type: none"> • RAN interface (77 0840 00) • TV installation kit (74 7002 56/15) 		
<p>Hospital LCD TV, professional 28" <i>Diagonal screen size: 70 cm, 28 inch</i></p>	74 7005 28/ 15	
<p>Hospital LCD TV, professional 32" <i>Diagonal screen size: 80 cm, 32 inch</i></p>	74 7005 32/ 15	
<p>Hospital LCD TV, professional 40" <i>Diagonal screen size: 100 cm, 40 inch</i></p>	74 7005 40/ 15	
<p>Hospital LCD TV, professional 48" <i>Diagonal screen size: 121 cm, 48 inch</i></p>	74 7005 48/ 15	
<p>Leather wristband MyAmie, white</p> <p>for radio trigger, order no. P6800x/0x.</p> <ul style="list-style-type: none"> • Packing unit: 1 <p><i>Dimensions (LxW): approx. 255 x 20 mm</i></p>	75 0870 62	



Specification	Order no.	
<p>Leather wristband MyAmie, black</p> <p>for radio trigger, order no. P6800x/0x.</p> <ul style="list-style-type: none"> Packing unit: 1 <p><i>Dimension (LxW): approx. 255 x 20 mm</i></p>	75 0870 63	
<p>19" Mounting set</p> <p>Mounting set for the installation of power supply modules or control units of the nurse call system in a 19" system cabinet or a 19" wall mounting cabinet. Width of the top hat rail: 425 mm.</p> <p>Sheet steel frame with pre-mounted top-hat rail and front cover. Integrated cable catch, strain relief and necessary accessories are included.</p> <p><i>Dimensions (HxWxD): 132,5 x 482,6 x 180 mm</i> <i>Mounting type: 19", 3 U</i> <i>Zinc-coated frame, red front cover.</i> <i>Frame material: Zinc-coated sheet steel</i> <i>Top-hat rail: TS 35/7.5, width: 425 mm</i></p>	76 0900 01	 <p>IP-SystemManager not included in scope of delivery</p>
<p>Mounting set for 10" wall mounting cabinet</p> <p>Mounting set for the installation of power supply modules or control units of the nurse call system in a 10" wall mounting cabinet. Width of the top hat rail: 203 mm.</p> <p>Sheet steel frame with pre-mounted top-hat rail. Integrated cable catch, strain relief and necessary accessories are included.</p> <p><i>Dimensions (HxWxD): 132,5 x 260 x 180 mm</i> <i>Mounting type: 10", 3 U</i> <i>Frame material: Zinc-coated sheet steel</i> <i>Top-hat rail: TS 35/7.5, width: 203 mm</i></p>	76 0900 02	

Specification	Order no.	
<p>DIN rail raiser HAGER HYA036 <i>for insulated mounting of modular units</i></p> <p>Required accessory for insulated mounting of modular units, e.g. for UPS control unit 10A (order no. 77341100) or DC UPS with capacitor storage, 6kWs (order no. 77341300).</p> <ul style="list-style-type: none"> • Length: 10.6 cm • Packing unit: 3 pieces • For insulated mounting, a distance of at least 1 cm to earthed parts must be maintained. • Max. 2 DIN rail raisers can be mounted in mounting set for 10" wall mounting cabinet (order no. 76 0900 02) • Max. 4 DIN rail raisers can be mounted in 19" mounting set (order no. 76 0900 01) <p><i>Dimensions (HxWxD): 42 x 106 x 35 mm</i></p>	<p>76 0900 04</p>	
<p>Network isolator LAN</p> <p>External network isolator for galvanic network separation according to EN 60601-1.</p> <ul style="list-style-type: none"> • Dielectric strength of signal and shielding: 5000 V • Operating mode: Continuous operation • Data throughput: 10/100/1000 Mbit/s • Ports: 2x RJ45 • Network specifications: IEEE 802.3 • Standards: Safety: EN / IEC 60601-1 3rd EMC: EN / IEC 60601-1-2 <p><i>Dimensions (HxWxD): 23 x 29 x 65 mm</i> <i>Weight: approx. 50 g</i></p>	<p>76 5000 00</p>	

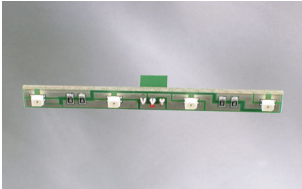
Specification	Order no.	
<p>Interface isolator RS232</p> <p>4 kV galvanic separated RS 232 isolator provides effective protection against external influences and fulfils the standard IEC 61850-3.</p> <ul style="list-style-type: none"> • 4 kV RSM galvanic separation • 15 kV ESD protection • Supply voltage: 24 V DC (from the nurse call system), max. 1 W • Diagnostic LEDs • Standard: IEC 61850-3 • Mounting on top-hat rail (35 mm) <p><i>Dimensions (HxWxD): 99 x 22.5 x 92 mm</i> <i>Weight: approx. 100 g</i></p>	<p>76 5010 00</p>	
<p>Doorplate universal</p> <p>Doorplate without light sections, universally applicable. Design adapted to Flamenco product family. Suitable for wall mounting in corridors or rooms. Modular design.</p> <ul style="list-style-type: none"> • Universal, modular doorplate • Label easy to change • Utility patent (DPMA) • Design patent (DPMA) • Easy installation <p><i>Dimensions (HxWxD): 190 x 150 x 40 mm</i> <i>Label field (HxW): approx. 70 x 92 mm</i></p>	<p>77 0189 00</p>	

Specification	Order no.	
<p>LED module, red</p> <p>Intended use in room lamps, order no. 77 017x xx and 77 018x xx.</p> <ul style="list-style-type: none"> • Applicable for all call types • Power supply: 24 V / 60 mA <p>Dimensions (HxWxD): 8 x 72 x 11 mm</p>	77 0190 00	
<p>LED module, yellow</p> <p>Intended use in room lamps, order no. 77 017x xx and 77 018x xx.</p> <ul style="list-style-type: none"> • Applicable for staff presence 2 • Power supply: 24 V / 60 mA <p>Dimensions (HxWxD): 8 x 72 x 11 mm</p>	77 0190 01	
<p>LED module, green</p> <p>Intended use in room lamps, order no. 77 017x xx and 77 018x xx.</p> <ul style="list-style-type: none"> • Applicable for staff presence 1 • Power supply: 24 V / 60 mA <p>Dimensions (HxWxD): 8 x 72 x 11 mm</p>	77 0190 02	
<p>LED module, white</p> <p>Intended use in room lamps, order no. 77 017x xx and 77 018x xx.</p> <ul style="list-style-type: none"> • Applicable for WC calls • Power supply: 24 V / 60 mA <p>Dimensions (HxWxD): 8 x 72 x 11 mm</p>	77 0190 03	
<p>LED module, blue</p> <p>Intended use in room lamps, order no. 77 017x xx and 77 018x xx.</p> <ul style="list-style-type: none"> • Applicable for Cardiac alarm (code blue) • Power supply: 24 V / 60 mA <p>Dimensions (HxWxD): 8 x 72 x 11 mm</p>	77 0190 04	





Specification	Order no.	
<p>Surface mounting box 1-gang for frame F</p> <p>e.g. for surface mounting of switches, product range 77 021x xx F.</p> <ul style="list-style-type: none"> • Surface mounting box incl. necessary accessories • Colour: Studio white • Housing material: Polycarbonate <p><i>Dimensions (HxWxD): 80 x 80 x 42 mm</i></p>	77 0210 55	
<p>Call switch cover</p> <p>Cover for call switches of the Flamenco or CONCENTO system. Made of transparent plastic for clear recognition of the switch. Flip cap with latching mechanism for secure locking and effortless call activation with just one hand.</p> <ul style="list-style-type: none"> • Housing material: Plastic • Colour: clear • Weight: 79 g <p><i>Dimensions (HxWxD): 120 x 100 x 44 mm</i></p>	77 0210 63	 <p>Switch not included in scope of supply</p>
<p>IR TV control module installation kit <i>for IR TV control module universal</i></p> <ul style="list-style-type: none"> • Loader for convenient and fast transfer of the configuration to further IR TV control modules • Terminal program on USB stick • USB to TTL adapter cable 	77 0360 40	
<p>ePat®/ePat[®]lite mounting bracket</p> <p>Mounting bracket made of plastic to hold an ePat® or an ePat[®]lite. As wall bracket or for mounting on the bedside cabinet.</p> <ul style="list-style-type: none"> • Colour: RAL 9016, traffic white • Material: ASA/PC • Required accessories (not included in delivery): 2 screws, screw thread M5, bugle head <p><i>Dimensions (HxWxD): 110 x 69 x 33 mm</i></p>	77 0380 00	

Specification	Order no.	
<p>ePat® clip</p> <p>Clip for attaching to an ePat® or ePat®lite to hang it in a Patient handset bracket, order no. 70 0800 00.</p> <ul style="list-style-type: none"> • Colour: RAL 9016, traffic white • Material: ASA/PC • Integrated metal plate made of stainless VA steel to use the holding force of the magnet integrated in the Patient handset bracket <p><i>Dimensions (HxWxD): 130 x 69 x 34 mm</i></p>	<p>77 0382 00</p>	
<p>NTP TimeServer/DCF</p> <p>The TimeServer receives time signals using DCF77 signals.</p> <p>It is a stand alone version and transfers the time signals via the Ethernet using the SNTP protocol.</p> <p>In conjunction with a system from the Flamenco system family and connection to the nurse call system IP network, the system time is updated automatically.</p> <ul style="list-style-type: none"> • Aluminium profile case, mounting on top-hat rail • Power supply: 19 – 72 VDC • Power consumption: 20 W • Receiving antenna in a waterproof plastic case for outdoor application • Web based status and configuration programme and graphic configuration tool for the console access <p><i>Dimensions (HxWxD): 105 x 125.5 x 189 mm</i></p>	<p>77 0910 10</p>	

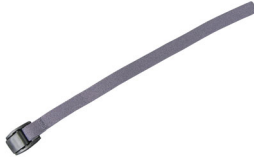
Specification	Order no.	
<p>10" Wall mounting cabinet, 6U, GD</p> <p>Wall mounting cabinet, suitable for the installation of power supply modules or control units of the nurse call system.</p> <ul style="list-style-type: none"> • Single opening glass front door, lockable • 200° door opening angle • 254 mm (10") profile rails on the front, variable in depth • Load capacity of profile rails: 30 kg • Ingress protection code: IP20 • 1.1 – 1.5 mm strong sheet steel with a high loading capacity, powder coated • Cable entry with brush strip on the top and plastic cover on the base • Ventilation slots for active and passive ventilation and exhausting <p><i>Weight: 5.5 kg</i> <i>Dimensions (HxWxD): 330 x 312 x 300 mm</i></p>	77 3510 06	
<p>19" Wall mounting cabinet, 7U, GD</p> <p>Wall mounting cabinet, suitable for the installation of power supply modules or control units of the nurse call system.</p> <ul style="list-style-type: none"> • Lockable safety-glass door with lateral metal struts • 210° door opening angle • 483 mm (19") profile rails mounted on the front side inside of the cabinet, are adjustable in depth • Load capacity of profile rails: 100 kg • Ingress protection code: IP20 • 1.1 – 1.5 mm strong sheet steel with a high loading capacity, powder coated • Cable entry on the rear side and base chassis with plastic cover and top with sliding cover • Roof is prepared for fan units (punched out entries) • Ventilation slots for active and passive ventilation and exhausting <p><i>Weight: 17 kg</i> <i>Dimensions (HxWxD): 420 x 600 x 450 mm</i></p>	77 3519 07	

Specification	Order no.	
<p>19" Wall mounting cabinet, 12U, GD</p> <p>Wall mounting cabinet, suitable for the installation of power supply modules or control units of the nurse call system.</p> <ul style="list-style-type: none"> • Lockable safety-glass door with lateral metal struts • 210° door opening angle • 483 mm (19") profile rails mounted on the front side inside of the cabinet, are adjustable in depth • Load capacity of profile rails: 100 kg • Ingress protection code IP20 • 1.1 – 1.5 mm strong sheet steel with a high loading capacity, powder coated • Cable entry on the rear side and base chassis with plastic cover and top with sliding cover • Roof is prepared for fan units (punched out entries) • Ventilation slots for active and passive ventilation and exhausting <p><i>Weight: 25 kg</i> <i>Dimensions (HxWxD): 643 x 600 x 450 mm</i></p>	<p>77 3519 12</p>	
<p>System computer</p> <p>System computer for the control of a ManagementCenter^{PC} or operating autonomous working software applications.</p> <p>Minimum configuration compatible to:</p> <ul style="list-style-type: none"> • Hard drive • Memory: 8 GB DDR4 • Graphic card • Optical drive: DVD writer • 2 network cards • Integrated loudspeaker • USB keyboard and USB mouse • Operating system Microsoft Windows 10 Professional 64-bit • Power supply: 230 V/50 Hz <p>The specification will be the standard specification at the time of delivery. Further details on request.</p>	<p>80 6010 00D</p>	

Specification	Order no.	
<p>SPD module for network cables <i>DPA M CLE RJ45B 48</i></p> <p>Surge arrester class E, fully shielded, tested acc. to EN 61643-21 for universal use acc. to EN 50173 up to 48 V DC for the protection of 4 pairs of data network interfaces via RJ45 socket, for single application or application in 19 inch cabinets, space-saving, width 19 mm.</p> <ul style="list-style-type: none"> • Max. continuous operating DC voltage: 48 V • Nominal current: 1 A • C2 Total nominal discharge current (8/20) line-PG: 10 kA • Mounting on 35 mm top hat rail <p><i>Dimensions (HxWxD): 75 x 19 x 36 mm</i></p>	<p>77 4900 02</p>	
<p>LCD monitor 19"</p> <p>Desktop installation.</p> <ul style="list-style-type: none"> • Panel type: IPS • Back light: WLED • Signal input: VGA, DVI • Resolution: 1280 x 1024 Pixel • Contrast: 5M:1 • Brightness: 250 cd/m² • Built-in speakers • Power supply: 230 V/50 Hz <p>The specification will be the standard specification at the time of delivery. Further details on request.</p>	<p>80 6049 00</p>	
<p>Wrist strap (10 mm) MyAmie</p> <p>for radio trigger, order no. P6800x/0x.</p> <ul style="list-style-type: none"> • Packing unit: 10 <p><i>Dimensions (LxW): approx. 180 x 10 mm</i></p>	<p>D6702135</p>	

Specification	Order no.	
<p>Belt clip MyAmie</p> <p>for radio trigger, order no. P6800x/0x. As an option the belt clip can be used for mounting the radio trigger on the wall, so that you have a fixed call switch.</p> <ul style="list-style-type: none"> • Packing unit: 10 	D6702136	 <p>MyAmie not included in scope of supply</p>
<p>Neckcord MyAmie, white</p> <p>for radio trigger, order no. P6800x/0x.</p> <ul style="list-style-type: none"> • Packing unit: 10 	D6702137	
<p>Wrist strap (20 mm) MyAmie</p> <p>for radio trigger, order no. P6800x/0x.</p> <ul style="list-style-type: none"> • Packing unit: 10 <p><i>Dimensions (LxW): approx. 210 x 10 mm</i></p>	D6702145	
<p>Neckcord MyAmie, black</p> <p>for radio trigger, order no. P6800x/0x.</p> <ul style="list-style-type: none"> • Packing unit: 10 	D6702155A	
<p>Magnetic wall bracket <i>for radio receiver-T</i></p> <p>Wall bracket for magnetic mounting of a radio receiver-T, order no. Z 00 8202 3x to the wall next to the connection socket.</p> <p><i>Dimensions (HxWxD): 64 x 40 x 12 mm</i></p>	Z 00 8202 21	